

CERAMICA
ALTHEA

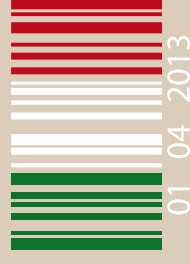



The Ceramica Althea creations are 100% Made in Italy

Starting from the **design of the products**, the highest quality of the **raw materials** up to the **production** exclusively made in the national plants of the company, in compliance with the **national and European Community regulations and directives**.

The **quality** of this process is expressed by the guarantee of the **"Made in Italy Certificate"**.

Ceramica Althea has obtained the concession of this certificate from the supervisory body of the Institute for the Protection of the Italian Manufacturers **"ITPI"**, that periodically subjects the company to a series of rigorous controls on quality, style, materials, **certifying** above all that the **entire production cycle** is entirely **made in Italy**.

The **"100% Made in Italy"** seal and the historical and proven production standards, allows **Ceramica Althea** to introduce in the market products of the highest quality and prestige, as well as to offer a guarantee of the utmost importance of the authenticity of the product.



Las creaciones de Ceramica Althea son Made in Italy al 100 %

A partir del **diseño de los productos**, las **materias primas** de la más alta calidad y por supuesto la **producción** realizada exclusivamente en los establecimientos nacionales de la empresa, en conformidad con las **normas** y las **directivas nacionales y comunitarias**.

La **calidad** de este proceso está **garantizada** con la marca **"Made in Italy Certificate"**.

Ceramica Althea ha obtenido la concesión de este certificado por el órgano de control - el Instituto para la Tutela de los Fabricantes Italianos **"ITPI"**, que somete periódicamente a la empresa a una serie de estrictos controles de calidad, de estilo, de materiales y sobre todo **certifica** que el **entero ciclo de producción** del producto está totalmente **realizado en Italia**.

La marca **"100% Made in Italy"** y los históricos y comprobados estándares de producción, permiten a **Ceramica Althea** introducir en el mercado un producto de altísima calidad y prestigio, así como ofrecer una definitiva garantía de la autenticidad del producto.



N° IT01.IT/698.023.M



Le creazioni Ceramica Althea sono Made in Italy al 100%

A partire dal **design dei prodotti**, la **materia prima** di altissima qualità e naturalmente la **produzione** realizzata esclusivamente negli stabilimenti nazionali dell'azienda, nel rispetto dei **regolamenti e direttive nazionali e comunitarie**.

La **qualità** di questo processo è espressa dalla **garanzia** del marchio **"Made in Italy Certificate"**.

Ceramica Althea ne ha ottenuto la concessione dall'organo di controllo, Istituto per la Tutela dei Produttori Italiani **(ITPI)**, il quale, sottopone periodicamente l'azienda ad una serie di rigorosi controlli sulla qualità, lo stile, i materiali e soprattutto **certifica** che l'**intero ciclo produttivo** del prodotto sia totalmente **realizzato in Italia**.

Il marchio **"100% Made in Italy"** e gli storici e comprovati standard produttivi, permettono alla **Ceramica Althea** di immettere nel mercato prodotti di altissima qualità e prestigio, oltre ad offrire un'importantissima garanzia dell'autenticità del prodotto.





awards



La forte attenzione per il design contraddistingue da sempre la produzione dell'azienda.

Nota per l'originalità dei suoi prodotti, **Ceramica Althea** affianca al proprio ufficio tecnico la creatività e la direzione artistica della designer **Maya Cohen**, alla quale si riconoscono creazioni che colpiscono per il **design ricercato**, che offre infinite soluzioni di forme e colori conferendo all'intera produzione **Althea** un tocco unico ed inconfondibile che la contraddistingue.

Questo valore aggiunto è attestato da numerosi riconoscimenti internazionali quali il **DESIGN PLUS**, il **GOOD DESIGN**, e le nomine al **DESIGNPREIS** per diversi prodotti, oltre che da prestigiose partecipazioni tra le quali l'esposizione alla **Triennale di Milano "The New Italian Design"** e alla manifestazione **RomaD+ "Design for Made in Italy"**.



The strong emphasis on design has always distinguished the company's production.

Known for the originality of its products, **Althea** besides its technical department is guided by the creativity and the artistic direction of the designer **Maya Cohen**, to whom are attributed creations that impress with their refined design, offering infinite shapes and colour solutions, giving the entire **Althea** production a unique and unmistakable touch that sets it apart.

This added value is attested by numerous international awards such as the **DESIGN PLUS**, **GOOD DESIGN**, and nominations to the **DESIGNPREIS** for various products, as well as prestigious participations including the exhibition at the **Milan Triennale "The New Italian Design"** and **RomaD+** event "**Design for Made in Italy**".



El fuerte énfasis en el diseño siempre ha sido un signo distintivo de la producción de la empresa.

Conocida por la originalidad de sus productos, **Ceramica Althea** une a su despacho técnico la creatividad y dirección artística de la diseñadora **Maya Cohen**, a la que se le reconocen creaciones que destacan por el diseño refinado, que ofrece infinitas soluciones de formas y colores confiriendo a toda la producción **Althea** un toque único e inconfundible que la distingue.

Numerosos premios internacionales como el **DESIGN PLUS**, el **GOOD DESIGN** y las nominaciones en el **DESIGNPREIS** para varios productos atestiguan este valor añadido, así como prestigiosas participaciones entre las cuales destaca la exposición en la **Triennale di Milano "The New Italian Design"** y la manifestación **RomaD + "Design for Made in Italy"**.

CERAMICA ALTHEA



Ceramica Althea è la prima e l'unica azienda del settore arredo bagno che certifica tutti i propri prodotti con il marchio "100% Made in Italy" a garanzia che l'intero ciclo produttivo del prodotto sia totalmente realizzato in Italia.

La **Ceramica Althea** nasce nel 1994 e rappresenta oggi, una realtà industriale consolidata a livello **nazionale ed internazionale**.

Negli stabilimenti della **Ceramica Althea SpA** si producono apparecchi igienico sanitari di altissima qualità, utilizzando impianti di **ultima generazione** che coniugano l'alta tecnologia degli stessi con l'esperienza e il know-how derivato da 20 anni di storia.

L'intero processo produttivo è caratterizzato da un alto grado di automazione sia nella fase di colaggio che nella fase di smaltatura condotta con sistemi robotizzati di ultima generazione, ma allo stesso tempo, viene preservata l'**arte della tradizione ceramica** attraverso una produzione più artigianale ancora fatta a mano.

I **controlli rigorosi** su tutte le fasi di lavorazione e l'attenzione formale dedicata allo studio dei prodotti fanno sì, che la produzione **Althea** rappresenti una delle più vaste gamme di prodotti ceramici presenti sul mercato, funzionali e soprattutto in grado di soddisfare ogni gusto e necessità.



Ceramica Althea is the first and only company in the bathroom furnishing sector certifying all its products with the "100% Made in Italy" certificate, ensuring that the entire production cycle is entirely made in Italy.

Ceramica Althea was established in 1994 and is today a company consolidated at **national and international** levels.

Ceramica Althea SpA produces in its manufacturing plants sanitary ware of the highest quality, using the **latest generation** systems that combine high technology to the experience and know-how, resulting from 20 years of experience.

The entire production process is characterized by a high degree of automation both at the casting and glazing stage carried out by robotic systems of the latest generation, but at the same time, preserving the **art of the ceramic traditions** through an artisan production still handmade.

The **rigorous controls** of all the working phases and the formal attention dedicated to the study of the products ensure, that the production **Althea** represents one of the widest ranges of ceramic products present on the market, functional and especially able to satisfy all tastes and needs.



Ceramica Althea es la primera y única empresa en el sector del baño que certifica todos sus productos bajo la marca "100% Made in Italy" con el fin de garantizar que el completo ciclo de producción del producto está totalmente realizado en Italia.

Ceramica Althea nace en 1994 y representa hoy una realidad industrial consolidada a nivel **nacional e internacional**.

En los establecimientos de **Ceramica Althea SpA** se producen artículos higiénicos sanitarios de la más alta calidad, utilizando los sistemas de **última generación** que combinan la elevada tecnología de los mismos con la experiencia y los conocimientos derivados de 20 años de historia.

Todo el proceso de producción se caracteriza por un alto grado de automatización tanto en la fase de colado como en la de esmalte, ambas realizadas con sistemas de robots de última generación, pero al mismo tiempo, se conserva el **arte de la tradición cerámica** a través de una producción más artesanal aún hecha a mano.

Los **estrictos controles** en todas las fases de trabajo y la atención formal dedicada al estudio de los productos permiten que la producción **Althea** represente una de las más amplias gamas de productos cerámicos existentes en el mercado, funcionales y sobre todo capaces de satisfacer todos los gustos y las necesidades.



**In environmental and performance terms
Ceramica Althea ensures standards of
excellence.**

During all the production stages maximum attention is paid to **energy efficiency, high performance** of machinery, **maximum reduction of pollutants released** into the atmosphere. Particular attention is also paid to the **industrial waste** that is **recycled and reused in the production process**, as well as waste resulting from the treatment of the working mixtures.

The very important aspect of **economizing water** is displayed also at the design stage, in fact all wc bowls are optimized for a **evacuation of 3.5 / 4 liters of water**.

The high **quality** offered by the company is recognized and attested by the **UNI EN ISO 9001:2008** certification, which regulates the quality management system starting from the human resources up to design and manufacture, and the control of the finished product, in accordance with a system designed to improve the service in order to increase the customer satisfaction.

In full compliance with the EU directives, the **Althea** products are **CE** marked in order to indicate that the product complies with all the Community provisions regarding its use starting from the design, production, the placing on the market and the putting into service of the product up to its disposal.

The company is internally provided with a **technical laboratory**, equipped with machinery for controlling **quality** and **functionality**, where the performance of the products is tested confirming the suitability for the introduction on the market.



**En términos ambientales y de prestación
Ceramica Althea garantiza un estándar
de excelencia.**

Durante todas las fases de la producción se concede la máxima atención a la **eficiencia energética**, al **alto rendimiento** de las máquinas, a la **máxima reducción de sustancias contaminantes** liberadas a la atmósfera. Una atención especial se presta a los **desechos del proceso industrial** que son **reciclados y reintroducidos en el ciclo de producción**, así como a las aguas residuales resultantes del tratamiento de la barbotina.

La cada vez más importante cuestión del **ahorro hídrico** comienza incluso en la fase de creación y desarrollo, de hecho todas las diferentes tipologías de inodoro están optimizadas para una **evacuación con 3.5 / 4 litros de agua**.

La elevada **calidad** ofrecida por la empresa es reconocida y comprobada por la certificación **UNI EN ISO 9001:2008** que regula el sistema de gestión de la calidad, desde los recursos humanos pasando por el desarrollo y fabricación, hasta el control del producto terminado, según un sistema dirigido a mejorar el servicio para aumentar la satisfacción del cliente cada vez más.

En plena conformidad con las directivas de la UE, los productos **Althea** tienen la marca **CE** con el fin de indicar que el producto cumple con todas las disposiciones comunitarias que prevén su uso desde el diseño y fabricación, a la comercialización y puesta en servicio del producto hasta su eliminación.

La empresa esta dotada de un propio **laboratorio técnico** interno equipado con sistemas de control de la **calidad** y **funcionalidad**, donde se prueba el funcionamiento del producto y se confirma luego la idoneidad para su comercialización.



**In termini ambientali e prestazionali
Ceramica Althea assicura standard
d'ecceellenza.**

Durante tutte le fasi produttive si pone massima attenzione all'**efficienza energetica**, all'**alto rendimento** dei **macchinari**, alla **massima riduzione** di **sostanze inquinanti** rilasciate nell'atmosfera. Una particolare attenzione è rivolta agli **scarti industriali** di lavorazione che vengono **riciclati e reimmessi nel ciclo produttivo**, così come le acque di scarico provenienti dalla lavorazione degli impasti.

L'importantissimo aspetto del **risparmio idrico** è proiettato anche nella fase di progettazione, infatti tutte le tipologie di wc sono ottimizzate per un'**evacuazione con 3,5 / 4 litri d'acqua**.

L'alta **qualità** offerta dall'azienda è riconosciuta e comprovata dalla certificazione **UNI EN ISO 9001:2008** che regola il sistema di gestione della qualità dalle risorse umane alla progettazione e produzione, fino al controllo del prodotto finito, secondo un sistema volto al miglioramento del servizio per incrementare sempre più la soddisfazione del cliente.

Nel pieno rispetto delle direttive comunitarie, i prodotti **Althea** sono marcati **CE** a indicare che il prodotto è conforme a tutte le disposizioni comunitarie che prevedono il suo utilizzo dalla progettazione, alla fabbricazione, all'immissione sul mercato, alla messa in servizio del prodotto fino allo smaltimento.

L'azienda è provvista al suo interno di un importantissimo **laboratorio tecnico**, provvisto di impianti di controllo della **qualità** e **funzionalità**, dove si testano le prestazioni dei prodotti confermandone l'idoneità all'immissione sul mercato.



Reg. No: 3619 - A

UNI EN ISO 9001:2008

SINCERT



Certification and research for quality



Il marchio Althea nel mondo.

The Althea Brand in the World.

La marca Althea en el mundo.

ALBANIA	EGITTO	ISLANDA	NUOVA ZELANDA	SINGAPORE
ALGERIA	EMIRATI ARABI	ISRAELE	OLANDA	SIRIA
AUSTRALIA	ESTONIA	ITALIA	OMAN	SLOVACCHIA
AUSTRIA	FILIPPINE	KAZAKISTAN	PAKISTAN	SLOVENIA
AZERBAIDJAN	FINLANDIA	KOSOVO	POLONIA	SPAGNA
BAHARAIN	FRANCIA	KUWAIT	PORTOGALLO	SVEZIA
BELGIO	GABON	LETTONIA	PRINCIPATO DI MONACO	SVIZZERA
BIELORUSSIA	GEORGIA	LIBANO	QATAR	TAIWAN
BOSNIA ERZEGOVINA	GERMANIA	LIBIA	REPUBBLICA ARMENA	THAILANDIA
BULGARIA	GHANA	LIECHTENSTEIN	REPUBBLICA CECA	TUNISIA
CAMERUN	GIAPPONE	LITUANIA	REPUBBLICA DEL BENIN	TURCHIA
CANADA	GIORDANIA	MACEDONIA	REPUBBLICA DI SAN MARINO	U.S.A.
CINA	GRAN BRETAGNA	MALTA	REPUBBLICA SUD AFRICANA	UCRAINA
CIPRO	GRECIA	MAROCCO	ROMANIA	UNGHERIA
COREA	HONG KONG	MONTENEGRO	RUSSIA	UZBEKISTAN
CROAZIA	INDIA	MOZAMBICO	SAUDI ARABIA	VENEZUELA
DANIMARCA	IRLANDA	NORVEGIA	SERBIA	YEMEN



The Althea brand represents in the motorsport as well as in the ceramic field the Italian excellence in the World.

Althea Racing is in fact four times World Champion in the Superbike and Superstock category. Through its long militancy in this extreme sport of great media appeal together with the successes achieved, Althea is the perception of great appeal and appreciation at international levels not only for its industrial capacity in the ceramics sector, but also as one of the best Teams in the world, a reference point for every rider or 2 wheels enthusiast.

The Althea Racing department is sited at the parent company of Ceramica Althea SpA, an avant-garde structure which houses offices, design and planning departments, workshops, test benches, spare parts warehouse and a development engine room where a team of experienced professionals and enthusiasts work together.

The Team's technical staff counts among its ranks the best engineers of the sector entrusted with the bike's technical direction on the racetrack, always available for the riders.

Strong attraction and destination of the "pilgrimage" of visitors from all over the world is the museum named "Moto dei Miti" which is part of the structure. In the same are on view more than 100 motorbikes that represent the best sport evidence and the world successes of each motorcycle category and manufacturer. Many of them are titled World Champions.



La marca Althea en el motociclismo, al igual que en el campo de la cerámica, representa la excelencia italiana en el mundo.

Althea Racing, de hecho, es cuatro veces Campeón del Mundo en la categoría Superbike y Superstock; a través de su larga militancia en este deporte extremo pero de gran atractivo mediático y con los éxitos alcanzados, la marca Althea es percibida con gran fascinación y admiración a nivel internacional, no sólo por su capacidad industrial en el campo de la cerámica, sino también como uno de los mejores Equipos del mundo y es una referencia para cualquier piloto o aficionado del motor.

El departamento de competición de Althea Racing tiene su sede en la casa madre Althea SpA, es una instalación a la vanguardia que aloja despachos, departamento de diseño, proyectación, talleres, bancos de prueba, almacén de repuestos y desarrollo motores, donde trabaja un equipo de profesionales expertos y apasionados.

El personal técnico del equipo cuenta entre sus filas los mejores ingenieros del sector que están encargados de la dirección técnica en pista de la moto a disposición de los pilotos.

Fuerte atracción y objeto de peregrinación de visitantes de todo el mundo es el Museo "Moto dei Miti", que es parte de la estructura. Están aquí expuestas más de 100 motos que representan los mejores testimonios deportivos y los éxitos mundiales de cada categoría y casas fabricantes. Muchas de ellas llevan el título de Campeón del Mundo.



Il marchio Althea nello sport motoristico, come nel campo della ceramica, rappresenta l'eccellenza italiana nel mondo.

Althea Racing, infatti, è quattro volte Campione del Mondo nella categoria Superbike e Superstock; attraverso la lunga militanza in questo sport estremo ma di grande appeal mediatico e con i successi conseguiti, il marchio Althea è percezione di grande fascino e di ammirazione a livello internazionale, non solo per la sua capacità industriale nel campo della ceramica, ma anche come uno dei migliori Team al mondo ed è un riferimento per qualsiasi pilota o appassionato dei motori.

Il reparto corse di Althea Racing ha sede nella casa madre di Althea SpA, è una struttura all'avanguardia che ospita uffici, reparto design, progettazione, officine, banchi prova, magazzino ricambi e sala sviluppo motori, dove lavora un team di professionisti esperti ed appassionati. Lo staff tecnico del team annovera tra le sue file i migliori ingegneri del settore, ai quali è affidata la direzione tecnica in pista della moto, a disposizione dei piloti.

Forte attrazione e oggetto di pellegrinaggio di visitatori da tutto il mondo è il museo "Moto dei miti", facente parte della struttura. In esso vengono esposte più di 100 moto che rappresentano le migliori testimonianze sportive ed i successi mondiali di ogni categoria e casa motociclistica. Molte di esse sono titolate Campione del Mondo.



INDICE GENERALE INDEX / ÍNDICE GENERAL

WC search

cover p. 16	oceano p. 48	soft p. 66	smart p. 92	fiò p. 116	
living swing linea p. 136	piatti doccia ito p. 148	piatti doccia hera p. 160			
outline p. 168	d-style p. 188	plus p. 208	hera p. 234	elle p. 256	easy small p. 274
royal p. 284	rose p. 314				
lavabi smart p. 328	lavabi stilo p. 342	lavabi d'arredo p. 350			
comfort p. 382					

filo muro / back to wall



filo muro / back to wall



specifiche tecniche
technical data
fichas técnicas
p. 386



certificazioni
certification
certificaciones
p. 440 - 441



Lavabi

Washbasins - Lavabos

55

55X48

40229 white
40230 black
40236 yellow
40244 green
40237 cherry
40238 grey
40235 platinum**70**

70X48

40310 white
40316 black
40312 yellow
40318 green
40314 cherry
40319 grey**80**

80X48

40320 white
40324 black
40321 yellow
40325 green
40322 cherry
40326 grey**80**

80X48

40313 white
40344 black
40342 yellow
40346 green
40345 cherry
40347 grey**90**

90X48

40349 white
40351 black
40350 yellow
40353 green
40352 cherry
40354 grey**100**

100X48

40311 white
40329 black
40317 yellow
40332 green
40327 cherry
40335 grey**120**

120X48

40337 white
40340 black
40338 yellow
40341 green
40339 cherry
40343 grey**45**

45X35

40582 white
40796 black
40799 yellow
40797 green
40795 cherry
40798 grey
40800 platinum**58**

58X35

40234 white
40240 black
40243 yellow
40245 green
40242 cherry
40241 grey
40239 platinum**70**

70X35

40583 white
40802 black
40805 yellow
40803 green
40801 cherry
40804 grey
40806 platinum**90**

90X35

40584 white
40808 black
40811 yellow
40809 green
40807 cherry
40810 grey
40812 platinum**80dx**

80X46

40813 white
40815 black**80sx**

80X46

40820 white
40822 black**58**

58X46



40359 white

**50**

50X37

40366 white
40371 black
40378 platinumscarico a pavimento
floor outlet
salida vertical40381 white
40382 black
40383 platinumscarico a parete
wall outlet
salida horizontal

Bidet

Bidet - Bidé

52

52X36

40372 white
40387 black**52**

52X36

40373 white
40394 black

WC

WC - Inodoro

52

52X36

40374 white
40386 black**52**

52X36

40375 white
40393 black

WC Monoblocco

Close-coupled WC - Inodoro para tanque bajo

60

60X36

40580 white
40767 black
+
40581 white
40768 black

WC + Totem

WC + Totem - Inodoro + Totem

66

66X40

40374 white
40386 black
+
40203 white
40204 blackConsumo d'acqua
Water flush
Consumo de aguaInstallazione:
Instalación:
Sospeso
Wall hung
Suspendido
Appoggio
Sit on top
Apoyo
Su colonna
With pedestal
Con pedestal
Con piedini
With legs
Con patas
Sottopiano
Under-counter
Bajo encimera
Semincasso
Semi recessed
Semiencastré
Su mobile
Cabinet basin
Con mueble



Scultorea, complessa, architettonica.
nella forma e nel materiale
la collezione di lavabi Cover
offre un'ampia versatilità funzionale:
semincasso, appoggio,
libera installazione e free-standing.
Un progetto di design
per un ambiente
bagno sofisticato ed elegante.

Statuesque, elaborate, architectural in
shape and material, the collection
of Cover washbasins offers
a wide functional versatility:
semi recessed, sit on top, free installation
and freestanding.
A design project
for a sophisticated
and elegant bathroom.

Escultórica, compleja, arquitectónica
en la forma y en el material,
la colección de lavabos Cover ofrece
una amplia versatilidad funcional:
semiencastré, de apoyo, libre
instalación y free-standing.
Un proyecto de design para
un ambiente baño sofisticado y elegante.

COVER



Il lavabo freestanding è uno dei prodotti icona della collezione Cover. Installato sia a muro che a centro stanza, il freestanding coinvolge lo spazio, libera dai vecchi schemi e dai criteri di serie.

The freestanding it is one of the icon products of Cover collection. Mounted to wall or freestanding, it involves the space freeing you from old schemes and standard sets.

El freestanding es uno de los productos iconos de la colección Cover. Instalado tanto a pared como al centro de la habitación, el freestanding envuelve el espacio, libera de los antiguos esquemas y de los criterios de serie.



Il platino è seducente;
basta uno sguardo
per essere
conquistati interamente
dal suo fascino
e un attimo
per riconoscergli valori reali
di bellezza, gusto, stile.

Platinum is seductive;
just a glance is sufficient to be
entirely won over by its
charm and it only takes
a moment to recognize
its values
of beauty, taste
and style.

El platino es seductor;
una mirada para
ser completamente
conquistados por su
encanto y un momento
para reconocerle los
valores reales de belleza,
gusto y estilo.



Cover freestanding platino: un prezioso gioiello.

Cover freestanding platinum: a precious jewel.

Cover freestanding platino: una joya preciosa.



Il profilo sottile rende
il Cover d'appoggio estremamente
leggero ed elegante.

The reduced profile confers
the sit on top Cover an extremely
light and elegant aspect.

El perfil sutil hace
el Cover de apoyo extremadamente
ligero y elegante.







Cover 58

Geometrie e organicità si fondono,
sviluppano vicendevolmente,
originando forme morbide e sensuali,
linee sinuose ma definite.
Una soluzione contemporanea,
interprete della complessità,
del carattere eclettico ed
internazionale della modernità.

Geometry and organicity blend,
melt and develop together,
giving life to soft and
sensual shapes, sinuous
but defined lines.
A contemporary solution which expounds
the complexities, international and
eclectic character of modernity.

Geometría y organicidad se funden,
se sueltan, se desarrollan
recíprocamente, originando
formas envolventes y sensuales, líneas
sinuosas pero definidas. Una solución
contemporánea que interpreta la complejidad,
el carácter ecléctico
e internacional de la modernidad.



Ampi raccordi, profili sottili e linee arrotondate.
Il giusto mix che dona grazia ed eleganza alla collezione Cover.

Wide connections, slim profiles and rounded lines.
The right combination that gives grace and elegance to the Cover collection.

Amplias conexiones, perfiles sutiles y líneas redondeadas.
La combinación adecuada que le da gracia y elegancia a la colección Cover.





Il lavabo Cover 80 con piano d'appoggio e portasalvietta integrato è disponibile nella versione destra e sinistra. In questa immagine lo vediamo abbinato ai sospesi.

The winged "Cover 80" basin with the towel bar integrated into the ceramic is available in the left and right hand versions. In this picture it is combined with the wall hung sanitary ware.

El lavabo Cover 80 con encimera de apoyo y toallero integrados está disponible en las versiones derecha e izquierda. En esta imagen está combinado con los suspendidos.





Cover 80 tutta vasca



Il design puro e neutrale consente
un facile inserimento in tutte le ambientazioni contemporanee.

The pure and neutral design
easily fits all contemporary settings.

El diseño puro y neutral fácilmente
encaja en cualquier ambiente contemporáneo.



Cover 80



Cover 55





Le linee pure del vaso a terra
 le ritroviamo intatte nella
 versione monoblocco.
 I volumi light che si prestano
 bene a descrivere forme minimali,
 importanti per caratterizzare non solo
 funzionalmente la zona w.c.



We find intact in the close-coupled
 version the pure lines of the floor sanitary
 ware collection. The volumes of
 this typology are well suited to
 describe minimal forms, important
 to characterize the bathroom area not
 only from the functional point of view.

Las líneas puras del inodoro al suelo
 se encuentran intactas en la versión para
 tanque bajo. Los volúmenes de este
 tipo son muy adecuados para
 describir formas mínimas, importantes
 para caracterizar no sólo
 funcionalmente la zona baño.



Cover 120

Coinvolge lo spazio,
libera dai vecchi
schemi ma soprattutto
raddoppia il piacere
di vivere l'ambiente bagno
in modo personale.

It involves space
freeing you from old
patterns but above all
it doubles the pleasure
of experiencing the
bathroom in a personal way.

Envuelve el espacio,
libera de los antiguos
esquemas pero sobre todo
duplica el placer
de experimentar el baño
de una manera personal.





COVER COMPACT 60 CM

E' la profondità di 60 cm a rendere il monoblocco Cover adattabile ad ogni esigenza di spazio.

It's the 60 cm depth that makes the "Cover" close-coupled WC adaptable to every requirement of space.

Es la profundidad de 60 cm que hace el Cover adaptable a cualquier exigencia de espacio.



Lavabi

Washbasins - Lavabos

50

50X45 OCEANO
30328 white

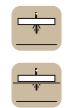

70

70X45 OCEANO
30329 white



80

80X45 OCEANO
30330 white

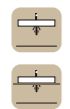

60

60X39 SMART
40132 white
40206 black



80

80X39 SMART
40137 white
40205 black



100

100X39 SMART
40138 white
40207 black



Bidet

Bidet - Bidé

54

54X38
30332 white



54

54X38
30334 white



WC

WC - Inodoro

54

54X38
30331 white



54

54X38
30333 white



WC Monoblocco

Close-coupled WC - Inodoro para tanque bajo

62

62X38
30424 white
+
30425 white



WC + Totem

WC + Totem - Inodoro + Totem

68

68X40
30331 white
+
40201 white
40202 black



Consumo d'acqua
Water flush
Consumo de agua

Installazione:
Instalación:



Sospeso
Wall hung
Suspendido



Appoggio
Sit on top
Apoyo



Su colonna
With pedestal
Con pedestal



Sottopiano
Under-counter
Bajoplano



Semincasso
Semirecessed
Bajo encimera



Su mobile
Cabinet basin
Con mueble



OCEANO

Scelte d'arredo di lunga vita, moduli lineari e precisi ma connotati da un'identità forte che piacerà per sempre. Oceano propone un programma in ceramica, in uno stile puro e razionale. Pezzi che, citando un design capace di abbinare contenuti estetici ad una grande funzionalità, offrono a molti una libertà compositiva improntata ad uno stile ricercato, generalmente destinato a pochi. In linea con il nuovo modo di abitare la casa.

Furnishing choices which last a lifetime, linear and precise forms however characterized by a strong identity that will be loved forever. Oceano proposes a ceramic programme, in a pure and rational style.

Pieces that, by exhibiting a design able to combine aesthetic contents and great functionality, offer to many a compositive liberty distinguished by a refined style, which is usually reserved for the few. In line with the new way of living in the home.

Diferentes elecciones para la decoración de larga vida, módulos lineales y precisos pero caracterizados por una identidad firme que gustará para siempre. Oceano propone un programa en cerámica, en un estilo puro y racional.

Piezas que, presentando un diseño capaz de combinar contenidos estéticos con una extensa funcionalidad, ofrecen a muchos una libertad de composición que guía hacia un estilo re buscando, generalmente destinado a pocos. En conformidad con la nueva manera de vivir la casa.

OCEANO 80

Iniziare la giornata sempre
con un desiderio. lo l'ho realizzato.
Mi piace la sua figura, perché le curve
sono più attraenti degli spigoli.
E la sua linea candida sa sempre come
ritagliarsi un ruolo da protagonista,
con classe.

Begin the day with a desire.
I have made it come true.
I like its shape, because curves are more
attractive than angles.
And its pure lines always gain it a
protagonist role with class.

Empezar el día siempre con un deseo.
Yo lo he realizado.
Me gusta su figura, ya que las curvas
atraen más que las aristas.
Y su línea cándida siempre sabe como
inventarse un papel de protagonista,
con carácter.







OCEANO 70

Everything is white: va in scena il bianco.
Everything is white: the white goes on stage.
Everything is white: entra en escena el blanco.



CLOSE - COUPLED WC



WC + TOTEM

Mi concedo venti minuti
di puro egoismo, tutti i giorni.

Every day I give myself
twenty minutes of pure selfishness.

Todos los días me concedo
veinte minutos de puro egoísmo.



OCEANO 80



La sostenibile leggerezza della ceramica.
Quando il design trasforma i sogni in realtà.
Silhouette seducenti e forme morbide
raccontano non solo funzioni, ma anche concetti.
Profili minimali installati a filo muro per sedute
sospese che sembrano sfidare la gravità.

The sustainable lightness of ceramics.
When design changes dreams into reality.
Seductive silhouettes and smooth shapes tell
not only of functions but also of concepts.
Minimal profiles installed flush to the wall for
suspended seats that seem to challenge gravity.

La sostenible ligereza de la cerámica.
Cuando el diseño cambia los sueños en
realidad. Siluetas seductivas y formas
indefinidas que cuentan no sólo funciones sino
también conceptos.
Perfiles minimalistas a nivel de la pared para
asientos que parecen desafiar la gravedad.



OCEANO 50

Cerco qualcosa che dimostri, in ogni situazione, il suo carattere, proprio come noi.
Oceano 50: forte impatto visivo e bordi enfatizzati: ideale anche nei piccoli spazi per realizzare combinazioni a due.

I'm looking for something able to prove its character in every situation, just like ourselves.
Oceano 50: strong visual impact and emphasised rims: ideal also in small spaces to realize twin combinations.

Busco algo que demuestre, en cada situación, su carácter, exactamente como nosotros.
Oceano 50: fuerte impacto visivo y aristas enfatizadas: ideal también en los espacios pequeños para realizar combinaciones a dos.



Lavabi

Washbasins - Lavabos

81

81X46 COVER

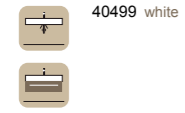

40499 white



91

91X46 COVER



40513 white



101

101X46 COVER



40520 white



80dx

80X46 COVER



40813 white
40815 black



80sx

80X46 COVER

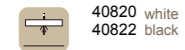

40820 white
40822 black



58

58X46 COVER



40359 white



Bidet

Bidet - Bidé

53

53X36

40557 / white

40557 white



48

48X36

40858 white



53

53X38

40558 white



WC

WC - Inodoro

53

53X36

40554 white



48

48X36

40857 white



53

53X38

40555 white



WC Monoblocco

Close-coupled WC - Inodoro para tanque bajo

60

60X36

40556 white

+
40559 white



Consumo d'acqua
Water flush
Consumo de agua

Installazione:
Instalación:



Sospeso
Wall hung
Suspendido



Appoggio
Sit on top
Apoyo



Su colonna
With pedestal
Con pedestal



Sottopiano
Under-counter
Bajoplano



Semincasso
Semirecessed
Bajo encimera



Su mobile
Cabinet basin
Con mueble

SOFT

SOFT THINGS

SOFT LIFE



COVER 80 DX - SX



Il lavabo Cover 80 dx abbinato ai sanitari sospesi Soft,
a completare l'ambiente le mensole in ceramica Elle e il piatto doccia Ito 140x80.

The "Cover" 80 winged right hand basin is combined with the "Soft" wall hung sanitary ware ,
the ceramic "Elle" shelves and the "Ito" shower tray 140x80 complete the scene.

El lavabo Cover 80 dcha combinado con los sanitarios suspendidos Soft,
completando el entorno las repisas en cerámica Elle y el plato de ducha Ito 140 x 80.



Le mensole in ceramica della collezione Elle, realizzate in cinque colori, danno una forte personalità alla sala da bagno.

The ceramic shelves of the "Elle" collection, available in five colours, give to the bathroom a strong personality.

Las repisas en cerámica de la colección Elle, disponibles en cinco colores, confieren una fuerte personalidad al cuarto de baño.



ITO

DESIGN

EXTRA SLIM



Piatto doccia Ito 140X80 extra piano.
Volumi puri per la massima versatilità di utilizzo.

"Ito" 140X80 extra slim shower tray.
Pure volumes for maximum versatility of use.

Plato de ducha Ito 140 x 80 extraplano.
Volúmenes puros para la máxima versatilidad de uso.



SOFTNESS

Lavabo sospeso Cover 58 in abbinamento con i sanitari a terra Soft.
Forme morbide per un comfort indispensabile.

"Cover" 58 wall hung basin combined with the "Soft" floor sanitary ware
Soft shapes for essential comfort.

Lavabo suspendido Cover 58 en combinación con los sanitarios al suelo Soft.
Formas suaves para una comodidad indispensable.





La morbidezza delle sue forme.
 Quel suo profilo deciso.
 Sa' di piacere e non lo nasconde.

The softness of its shape.
 Its clean profile.
 It knows its on worth and doesn't try to hide it.

La suavidad de sus formas.
 Ese perfil decidido.
 Sabe a placer y no se esconde.



FILO MURO USCITA DUAL

BACK TO WALL DUAL SYSTEM
 ADOSADO A PARED SALIDA DUAL

WC e bidet a terra Soft
 sono a filo muro.

"Soft" back to wall
 floor standing WC and bidet.

Los inodoros y bidés Soft
 al suelo son adosados a pared.





COVER 58



COMPLEMENTI
FURNISHING ACCESSORIES / COMPLEMENTOS

LINEA



La collezione Linea impreziosisce l'ambiente bagno con mobili a colonna, carrelli e tanti altri indispensabili complementi d'arredo.

The "Linea" collection embellishes the bathroom setting with wall hung high cabinets, floor cabinets on castors and many other essential furnishing accessories.

La colección Linea adorna el baño con muebles, columnas, auxiliares y muchos otros complementos esenciales de decoración.



COMPACT 60 CM

Monoblocco Soft Compact e bidet a terra
in abbinamento al lavabo Cover 80 DX.
Dimensioni ridotte per la massima
versatilità di utilizzo.

"Soft" Compact close-coupled WC and bidet
combined with the "Cover" 80 winged right hand basin.
Small sizes for maximum
versatility of use.

Inodoro para tanque bajo Soft Compact y bidé al suelo
combinados con el lavabo Cover 80 dcha.
Dimensiones reducidas para la máxima
versatilidad de uso.

SOFT COMPACT 60 CM

E' la profondità di 60 cm a rendere il monoblocco Soft adattabile ad ogni esigenza di spazio.

It's the 60 cm depth that makes the "Soft" close-coupled WC adaptable to every requirement of space.

Es la profundidad de 60 cm que hace el inodoro para tanque bajo Soft adaptable a cualquier exigencia de espacio.





Disponibile nelle versioni DX e SX, il lavabo Cover 80 è caratterizzato dal porta salviette completamente integrato nella ceramica. Cura e precisione nei dettagli, perchè nulla è lasciato al caso.

Available in the left and right hand version, the "Cover" 80 basin is characterized by the towel bar completely integrated into the ceramic. Attention and precision to detail, nothing is left to chance.

Disponibile en las versiones de derecha e izquierda, el lavabo Cover está caracterizado por el toallero totalmente integrado en la cerámica. Cuidado y precisión en los detalles, porque nada se deja al azar.



LIVING

Lavabo Cover Plain 101 su mobile Living
in abbinamento ai sanitari a terra Soft.
Pensili e specchio della collezione Linea
completano l'ambiente.

"Cover Plain" 101 basin on the "Living" cabinet
combined with the "Soft" floor sanitary ware
Wall cabinets and mirror from the "Linea" collection
complete the scene.

Lavabo Cover Plain 101 sobre el mueble Living
en combinación con los sanitarios al suelo Soft.
Camerinos y espejo de la colección Linea
completan el ambiente.





Con uno spessore di 3 cm
il lavabo Cover Plain si abbina
perfettamente al mobile Living 100
e ai complementi Linea, specchio e pensile.

With a depth of 3 cm
the "Cover Plain" basin perfectly
combines both with the "Living" 100 cabinet
and the "Linea" accessories, mirror and wall cabinet.

Con 3 cm de espesor
el lavabo Cover Plain se combina
perfectamente con el mueble Living 100
y con los accesorios Linea, espejo y camerino.



Lavabi

Washbasins - Lavabos

50
50X39 CLEVER
30381 white

50
50X39 CLEVER
30382 white

60
60X39 CLEVER
30383 white

70
70X39 CLEVER
30384 white

80
80X39 CLEVER
30385 white

90
90X39 CLEVER
30386 white

100
100X39 CLEVER
30387 white

39
PROFONDITÀ
DEPTH - PROFUNDIDAD

61
61X46 CLEVER
40477 white

81
81X46 CLEVER
40479 white

91
91X46 CLEVER
40480 white

101
101X46 CLEVER
40481 white

46
PROFONDITÀ
DEPTH - PROFUNDIDAD

Bidet

Bidet - Bidé

52
52X36

40567 white

52
52X36

40569 white

WC

WC - Inodoro

52
52X36

40566 white

52
52X36

40568 white

3/4.5
water saving

WC Monoblocco

Close-coupled WC - Inodoro para tanque bajo

60
60X36

40570 white
+
40571 white

3/4.5
water saving

3/4.5
water saving
Consumo d'acqua
Water flush
Consumo de agua

Installazione:
Instalación:

- Sospeso**
Wall hung
Suspendido
- Appoggio**
Sit on top
Apoyo
- Su colonna**
With pedestal
Con pedestal
- Con piedini**
With legs
Con patas
- Sottopiano**
Under-counter
Bajo encimera
- Semincasso**
Semi recessed
Semiencastré
- Su mobile**
Cabinet basin
Con mueble

SMART

Lavabo Clever 80 con mobile Living, colonne Linea, piatto doccia Ito, in abbinamento con i sanitari sospesi Smart.

"Clever" 80 basin with the "Living" cabinet, "Linea" wall hung high cabinets, "Ito" shower tray, combined with the "Smart" wall hung sanitary ware.

Lavabo Clever 80 sobre el mueble Living, columnas Linea, platos de ducha Ito, en combinación con los sanitarios suspendidos Smart.



Design e funzionalita' si fondono
per ottimizzare lo spazio:
nascono i sanitari sospesi Smart.

Design and functionality merge
to optimize space:
the "Smart" wall hung sanitary ware comes to life.

Diseño y funcionalidad se funden
para optimizar el espacio:
nacen los sanitarios suspendidos Smart.





Colonne, armadietti, carrelli e numerose altre soluzioni d'arredo per chi non sa rinunciare all'organizzazione di piccoli e grandi spazi.

Wall hung high cabinets, wall cabinets, floor cabinets on castors and many other design solutions for those who do not wish to relinquish the organization of small and large spaces.

Columnas, armarios y carros auxiliares y numerosas otras soluciones de decoración para aquellos que no quieren renunciar a la organización de pequeños y grandes espacios.



ito

140X80



Semplicemente

Lavabo Clever 80 sospeso,
carrello Linea, in abbinamento
ai sanitari a terra Smart.
Nulla è più elegante della semplicità.

"Clever" 80 wall hung basin,
"Linea" floor cabinet on castors, combined
with the "Smart" floor sanitary ware.
Nothing is more elegant than simplicity.

Lavabo Clever 80 suspendido,
carro auxiliar Línea, en combinación con
los sanitarios al suelo Smart.
Nada es más elegante que la simplicidad.

SMART



FILO MURO USCITA DUAL

BACK TO WALL DUAL SYSTEM - ADOSADO A PARED SALIDA DUAL

WC e bidet a terra Smart sono a filo muro.

"Smart" back to wall floor standing WC and bidet.

Los inodoros y bidés Smart al suelo son adosados a pared.





CLEVER 80X39

Il lavabo Clever in appena 39 cm di profondità offre un'ampia vasca e un comodo piano d'appoggio posteriore.

The "Clever" basin with a depth of just 39 cm offers a wide basin and a comfortable back ledge.

El lavabo Clever en sólo 39 cm de profundidad ofrece un seno muy amplio y un cómodo plano de apoyo posterior.



SMARTCOMPACT60CM

Monoblocco Compact Smart e bidet in abbinamento al lavabo Clever sospeso. Colonna, Specchio ed appliques Linea.

"Smart" close-coupled WC and bidet combined with the "Clever" wall hung basin. Wall hung high cabinet, mirror and "Linea" spotlights.

Inodoro para tanque bajo Compact Smart y bidé en combinación con el lavabo Clever suspendido. Columna, Espejo y apliques Linea.



MONOBLOCCO COMPACT 60CM

Il monoblocco Smart offre il massimo della funzionalità in appena 60 cm di profondità, senza rinunciare alla comodità e al design ricercato.

"Smart" close-coupled WC offers maximum functionality in a depth of just 60 cm, without sacrificing comfort and refined design.

El inodoro para tanque bajo Smart ofrece máxima funcionalidad en sólo 60 cm de profundidad sin renunciar al confort y al diseño refinado.





CLEVER 81X46

L'offerta continua sulla gamma di lavabi Clever con l'aggiunta della nuova versione con profondità di 46 cm. Ideale in appoggio sul mobile o sospeso a parete.

The offer continues on the "Clever" range of basins with the addition of the new version with a depth of 46 cm. Ideal on a furniture unit or wall hung.

La oferta continúa en la gama de lavabos Clever con la evolución a la nueva versión de 46 cm de profundidad. Ideal para apoyo encima del mueble o suspendido a pared.





Sanitari sospesi Smart in abbinamento al lavabo d'appoggio Small, perfetti per un ambiente piccolo ma elegante.

Smart wall hung sanitary ware combined with the "Small" sit on top basin, perfect in a small but elegant bathroom.

Sanitarios suspendidos Smart combinados con el lavabo de apoyo Small, ideales para un ambiente pequeño pero elegante.

Lavabi

Washbasins - Lavabos

71
71X46 PINK
40546 white



81
81X46 PINK
40547 white



91
91X46 PINK
40548 white



101
101X46 PINK
40549 white





61
61X46 STILO
40482 white



81
81X46 STILO
40483 white



101
101X46 STILO
40484 white



Bidet

Bidet - Bidé

52
52X36
40575 white



52
52X36
40577 white



WC

WC - Inodoro

52
52X36
40574 white



52
52X36
40576 white



Consumo d'acqua
Water flush
Consumo de agua

WC Monoblocco

Close-coupled WC - Inodoro para tanque bajo

60
60X36



40578 white
+
40579 white



Installazione:
Installation:
Instalación:



Sospeso
Wall hung
Suspendido



Appoggio
Sit on top
Apoyo



Su colonna
With pedestal
Con pedestal



Con piedini
With legs
Con patas



Sottopiano
Under-counter
Bajo encimera



Semincasso
Semi recessed
Semiencastré



Su mobile
Cabinet basin
Con mueble

Pink/Flò



Lavabo Pink 81 su mobile Swing beige
abbinato ai sanitari Flò sospesi.

"Pink" 81 basin on "Swing" beige cabinet
combined with the "Flò" bathroom wall hung sanitary ware.

Lavabo Pink 81 sobre el mueble Swing beige
combinado con los sanitarios Flò suspendidos.



Flò

Eleganti e discreti i sospesi Flò diventano protagonisti indiscussi dell'ambiente bagno.

Elegant and discreet the "Flò" wall hung sanitary ware becomes undisputed protagonist of the bathroom.

Elegantes y discretos los suspendidos Flò se convierten en los protagonistas indiscutibles del baño.





I complementi Linea, specchio con pensile e applique arricchiscono la composizione del lavabo Pink con mobile Swing.

The "Linea" accessories, mirror plus wall cabinet and spotlight enrich the composition of the "Pink" basin with the "Swing" cabinet.

Los accesorios Linea, espejo con camerino y aplique enriquecen la composición del lavabo Pink con el mueble Swing.

Stilo / Flò



Lavabo Stilo 101 su mobile Swing wengè
abbinato ai sanitari Flò a terra.

"Stilo" 101 basin on "Swing" wenge cabinet
combined with the "Flò" floor sanitary ware collection.

Lavabo Stilo 101 sobre el mueble Swing wengè
combinado con los sanitarios Flò al suelo.



WC e bidet a terra Flò
sono a filo muro.

"Flò" back to wall
floor standing WC and bidet.

Los inodoros y bidés Flò
al suelo son adosados a pared.

Flò filo muro uscita dual - back to wall dual system - adosado a pared salida dual



Stilo 101 / Swing wengé



Pink/Flò

COMPACT 60 cm

Lavabo Pink 71 sospeso
abbinato a wc monoblocco e bidet Flò.

"Pink" 71 wall hung basin
combined with the "Flò" close-coupled WC and bidet.

Lavabo Pink 71 suspendido
combinado con el inodoro para tanque bajo y bidé Flò.



Geometrie essenziali e linee sobrie
per la gamma di lavabi Pink.

Essential geometry and sober lines
for the range of "Pink" washbasins.

Geometrías esenciales y líneas sobrias
para la gama de lavabos Pink.



Flò

COMPACT 60 cm

Il wc monoblocco Flò in soli 60 cm di profondità coniuga design e funzionalità.

The "Flò" close-coupled with a depth of just 60 cm combines design and functionality.

El inodoro para tanque bajo Flò en tan solo 60 cm de profundidad combina diseño y funcionalidad.



LIVING CAFFÈ



Lavabo Cover Plain 101 su mobile Living. Pensili e specchio della collezione Linea completano l'ambiente.

"Cover Plain" 101 basin on the "Living" cabinet. Wall cabinets and mirror from the "Linea" collection complete the scene.

Lavabo Cover Plain 101 sobre el mueble Living. Camerinos y espejo de la colección Linea completan el ambiente.





Lavabo Clever 80 con mobile Living, colonna Linea.

"Clever" 80 basin with the "Living" cabinet and "Linea" wall hung high cabinet.

Lavabo Clever 80 sobre el mueble Living y columna Linea.





I complementi Linea, specchio con pensile e applique arricchiscono la composizione del lavabo Pink con mobile Swing.

The "Linea" accessories, mirror plus wall cabinet and spotlight enrich the composition of the "Pink" basin with the "Swing" cabinet.

Los accesorios Linea, espejo con camerino y applique enriquecen la composición del lavabo Pink con el mueble Swing.

SWING

WENGÈ



Il Lavabo Stilo 101 su mobile Swing wengè con zampe cromate, abbinato allo specchio a filo lucido.

"Stilo" 101 basin on "Swing" wengè cabinet with chrome legs, combined with the glossy flush mirror.

Lavabo Stilo 101 sobre el mueble Swing wengè con patas cromadas, combinado con el espejo.



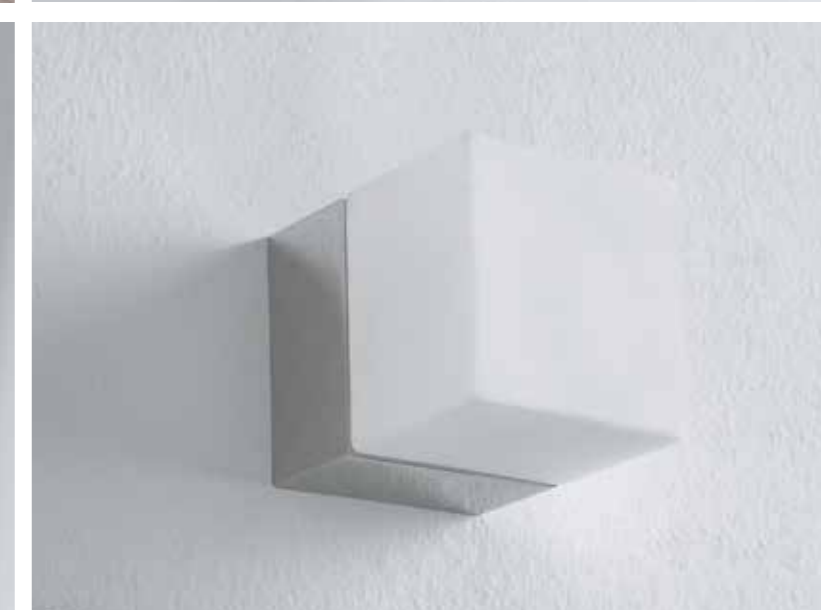

LINEA

COMPLEMENTI
FURNISHING ACCESSORIES / COMPLEMENTOS



La collezione Linea impreziosisce l'ambiente bagno con mobili a colonna, carrelli e tanti altri indispensabili complementi d'arredo.

The "Linea" collection embellishes the bathroom setting with wall hung high cabinets, floor cabinets on castors and many other essential furnishing accessories.

La colección Linea adorna el baño con muebles, columnas, auxiliares y muchos otros complementos esenciales de decoración.

Piatti doccia

Shower trays - Platos de ducha

110





110X75 OUTLINE

-  40171 white
-  40172 black
-  40174 yellow
-  40175 green
-  40173 cherry



90





90X90

-  40250 white
-  40260 black
-  40261 yellow
-  40262 grey
-  40263 cherry



80





80X80

-  40249 white
-  40256 black
-  40257 yellow
-  40258 grey
-  40259 cherry



100





100X100

-  P2065D01A white
-  P2065D04A black
-  P2065D11A yellow
-  P2065D07A grey
-  P2065D02A cherry



90





90X90

-  40402 white
-  40475 black
-  40474 yellow
-  40473 grey
-  40472 cherry



80





80X80

-  40251 white
-  40264 black
-  40265 yellow
-  40266 grey
-  40267 cherry



170

170X70

-  40842 white
-  40844 black
-  40846 yellow
-  40845 grey
-  40843 cherry



160





160X70

-  40837 white
-  40839 black
-  40841 yellow
-  40840 grey
-  40838 cherry



140





140X80

-  40401 white
-  40471 black
-  40470 yellow
-  40469 grey
-  40468 cherry



140





140X70

-  40328 white
-  40333 black
-  40330 yellow
-  40334 grey
-  40331 cherry



120





120X80

-  40400 white
-  40434 black
-  40467 yellow
-  40466 grey
-  40465 cherry



120





120X75

-  P2065201A white
-  P2065204A black
-  P2065211A yellow
-  P2065207A grey
-  P2065202A cherry



120





120X70

-  40398 white
-  40460 black
-  40459 yellow
-  40458 grey
-  40457 cherry



100





100X80

-  40399 white
-  40464 black
-  40463 yellow
-  40462 grey
-  40461 cherry



100





100X75

-  P2065101A white
-  P2065104A black
-  P2065111A yellow
-  P2065107A grey
-  P2065102A cherry



100





100X70

-  40397 white
-  40456 black
-  40455 yellow
-  40454 grey
-  40453 cherry



90





90X72

-  40248 white
-  40252 black
-  40253 yellow
-  40254 grey
-  40255 cherry



90dx





90X72

-  40827 white
-  40829 black
-  40831 yellow
-  40830 grey
-  40828 cherry



90sx

90X72

-  40832 white
-  40834 black
-  40836 yellow
-  40835 grey
-  40833 cherry



Installazione:
Installation:
Instalación:



Lato non smaltato
Unglazed side
Lado no esmaltado

Filo pavimento
Low profile shower tray
Ras de pavimento

Appoggio su pavimento
Standard shower tray
De apoyo al pavimento



ito
cm 120X75

ito collection

piatti doccia **ito**

L'eleganza dei profili sottili,
la purezza delle forme lineari.
Si chiama ITO,
la gamma di piatti doccia
extra piani di Althea.

The elegance of the reduced
profiles, the purity of linear
forms. It is named ITO,
the Althea extra slim range of
shower trays.

La elegancia sutil de los
perfiles, la pureza de las
formas lineales. Se llama ITO,
la gama de platos de ducha
extraplano de Althea.

extra



gamma quadrati

cm 80X80 - cm 90X90

extra

slim





gamma rettangolari

cm 90X72 - cm 100X70 - cm 100X75 - cm 100X80 - cm 120X70 - cm 120X75
cm 120X80 - cm 140X70 - cm 140X80 - cm 160X70 - cm 170X70

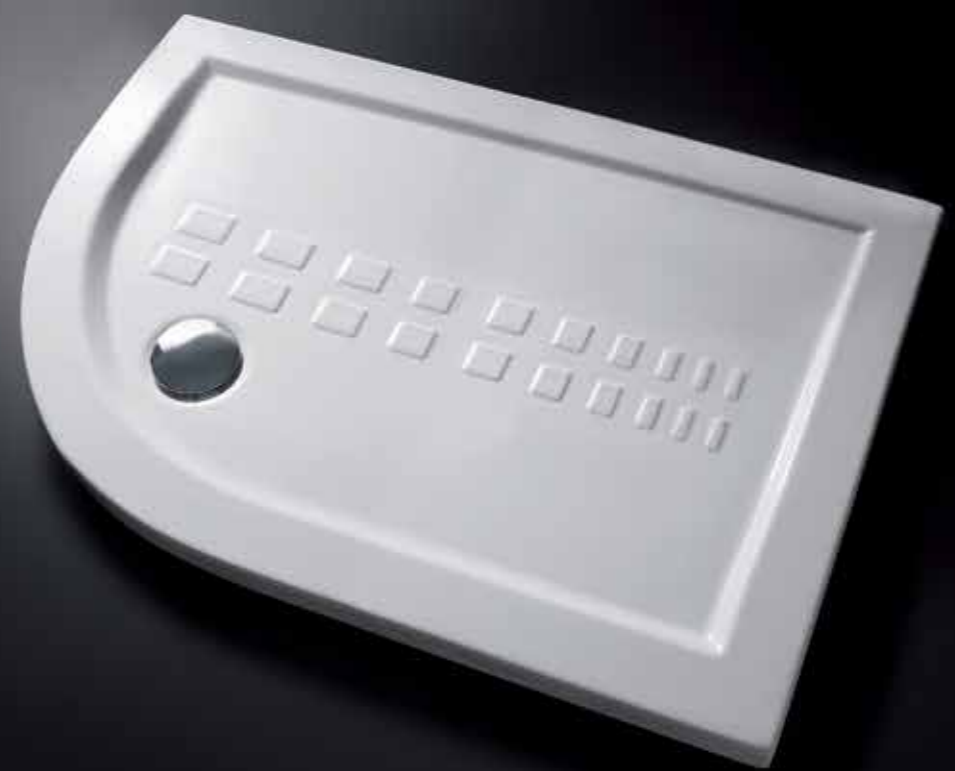

gamma rettangolari angolari

cm 90X72 DX - cm 90X72 SX

ito
colours



gamma angolari

cm 80X80 - cm 90X90 - cm 100X100



● white



● cherry



● grey



● black



● yellow

OUTLINE

cm 110x75



Le forme morbide della collezione Outline si trasferiscono sul piatto doccia offrendo all'ambiente bagno una completezza unica.

piatto doccia **OUTLINE**

The soft lines of the Outline collection materialize on the shower tray, making the bathroom environment even more unique.

Las líneas suaves de la colección Outline se materializan en el plato de ducha, por lo que el baño se hace aún más único.

Piatti doccia

Shower trays - Platos de ducha

90
90X90

31078 white



80
80X80

31077 white



72
72X72

31076 white



90
90X90

31081 white



80
80X80

31080 white



140
140X80

40396 white



140
140X70

40395 white



120
120X80

31087 white



120
120X70

31086 white



100
100X80

30342 white



100
100X70

31085 white



90
90X72

31084 white



85
85X70

31083 white



Installazione:
Installation:
Instalación:



*
Lato non smaltato
Unglazed side
Lado no esmaltado



Appoggio su pavimento
Standard shower tray
De apoyo al pavimento



La collezione Althea si completa di una versatile selezione di piatti doccia. Realizzati secondo una filosofia progettuale ambiziosa che sposa alla praticità di uso quella della pulizia, tutti gli elementi si caratterizzano per la loro sobria eleganza che supera il concetto di "monoesigenza".

Acqua form

Piatti doccia



Althea collection is completed by a versatile selection of shower trays. Produced with an ambitious design philosophy that combines the practicality of use and cleaning, all the elements are characterized by their simple elegance that goes beyond the concept of "one-need".

La colección Althea se completa con una versátil gama de platos de ducha. Producidos según una filosofía de diseño ambicioso que combina la comodidad del uso con la limpieza, todos los elementos se caracterizan por su sobria elegancia que va más allá del concepto de "monoexigencia".

Linee square per un look



gamma quadrati

cm 72X72 - cm 80X80 - cm 90X90

giovane e di tendenza.



gamma rettangolari

cm 85X70 - cm 90X72 - cm 100X70 - cm 100X80 - 120X70 - 120X80 - 140X70 - 140X80

Il tema del bianco,
il rigore formale,
sono gli elementi che
caratterizzano il
forte impatto estetico.

The theme of white
and the formal rigour
are the elements that
characterize the strong
aesthetic impact.

El tema del blanco
y el rigor formal son
los elementos que
caracterizan el fuerte
impacto estético.



gamma angolari

cm 80X80 - cm 90X90



Lavabi

Washbasins - Lavabos

50
50X33



- 30352 white
- 30484 black
- 30487 white/cherry
- 30489 white/black
- 30486 white/yellow
- 30488 white/green
- 40104 black/bijoux
- 40103 white/bijoux



60
60X48



- 30351 white
- 30476 black
- 30481 white/cherry
- 30483 white/black
- 30480 white/yellow
- 30482 white/green
- 40106 black/bijoux
- 40105 white/bijoux



70
70X48



- 30350 white
- 30428 black
- 30473 white/cherry
- 30475 white/black
- 30472 white/yellow
- 30474 white/green
- 40108 black/bijoux
- 40107 white/bijoux



90
90X48



- 30349 white
- 30377 black
- 30467 white/cherry
- 30469 white/black
- 30466 white/yellow
- 30468 white/green
- 40110 black/bijoux
- 40109 white/bijoux



110
110X75



- 40171 white
- 40172 black
- 40174 yellow
- 40175 green
- 40173 cherry



Bidet

Bidet - Bidé

55
55X39



- 30344 white
- 30419 black
- 30446 white/cherry
- 30448 white/black
- 30445 white/yellow
- 30447 white/green
- 40118 black/bijoux
- 40117 white/bijoux



55
55X39



- 30346 white
- 30432 black
- 30456 white/cherry
- 30458 white/black
- 30455 white/yellow
- 30457 white/green
- 40124 black/bijoux
- 40123 white/bijoux



WC

WC - Inodoro

55
55X39



- 30343 white
- 30378 black
- 30442 white/cherry
- 30444 white/black
- 30441 white/yellow
- 30443 white/green
- 40120 black/bijoux
- 40119 white/bijoux



- 30548 white
- 30559 black
- 30557 white/cherry
- 30555 white/black
- 30554 white/yellow
- 30556 white/green
- 40122 black/bijoux
- 40121 white/bijoux



55
55X39



- 30345 white
- 30431 black
- 30451 white/cherry
- 30453 white/black
- 30450 white/yellow
- 30452 white/green
- 40126 black/bijoux
- 40125 white/bijoux



WC + Totem

WC + Totem - Inodoro + Totem

69
69X40



- 30343 white
- 30378 black
- 30442 white/cherry
- 30444 white/black
- 30441 white/yellow
- 30443 white/green
- 40120 black/bijoux
- 40119 white/bijoux



- 30548 white
- 30559 black
- 30557 white/cherry
- 30555 white/black
- 30554 white/yellow
- 30556 white/green
- 40122 black/bijoux
- 40121 white/bijoux



WC Baby

WC Baby - Inodoro Baby

40
40X31



- 30348 white
- 30460 black
- 30462 white/cherry
- 30464 white/black
- 30461 white/yellow
- 30463 white/green



Consumo d'acqua
Water flush
Consumo de agua

Installazione:
Instalación:



Sospeso
Wall hung
Suspendido



Appoggio
Sit on top
Apoyo



Su colonna
With pedestal
Con pedestal



Con piedini
With legs
Con patas



Sottopiano
Under-counter
Bajo encimera



Semincasso
Semi recessed
Semiencastré



Su mobile
Cabinet basin
Con mueble

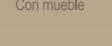

Installazione:
Instalación:



Lato non smaltato
Un-glazed side
Lado no esmaltado



Installazione:
Instalación:

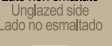

Appoggio su pavimento
Standard shower tray
De apoyo al pavimento



DESIGN PLUS
2007



DESIGNPREIS
2008
NOMINEE

OUTLINE

V E D E R E O L T R E

Vintage idea



Outline è un omaggio appassionato allo stile e allo spirito degli anni '60.
Linee forti. Colori decisi. Idee diverse. E' il vintage che prende vita.
E trasforma il bagno.

Outline is a passionate tribute to the style and the spirit of the '60.
Strong lines. Bold colours. New ideas.
It's vintage that comes to life. And transforms the bathroom.

Outline es un homenaje apasionado al estilo y al espíritu de los
años '60. Líneas fuertes. Colores firmes. Ideas diferentes.
Es el vintage que toma vida. Y transforma el baño.

The opposite of colour

Tutti i colori fanno il bianco.
Nessun colore fa il nero.
Tutti i colori e nessun
colore insieme fanno Outline Black&White.



Black& White...



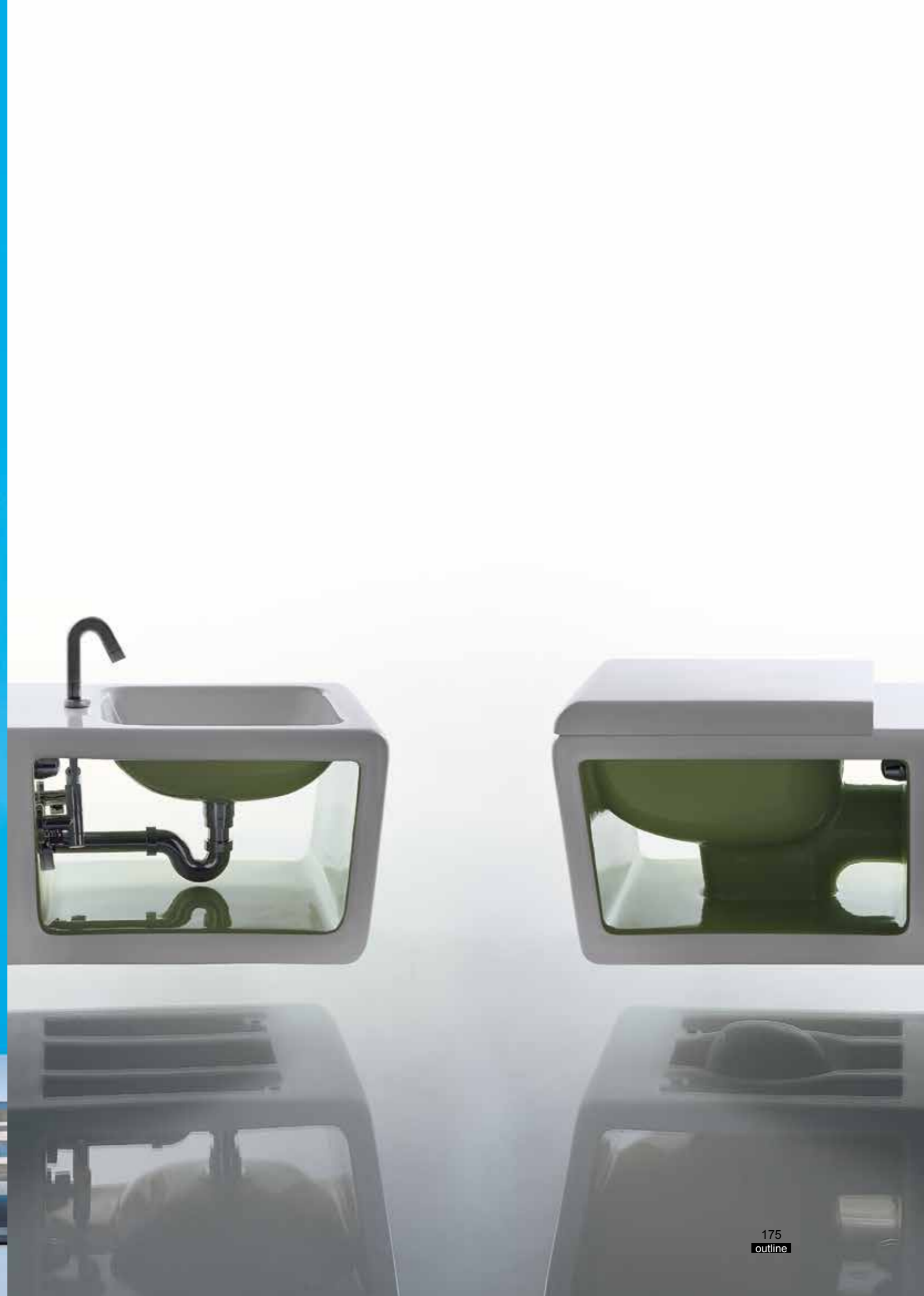

Hypnotic outline

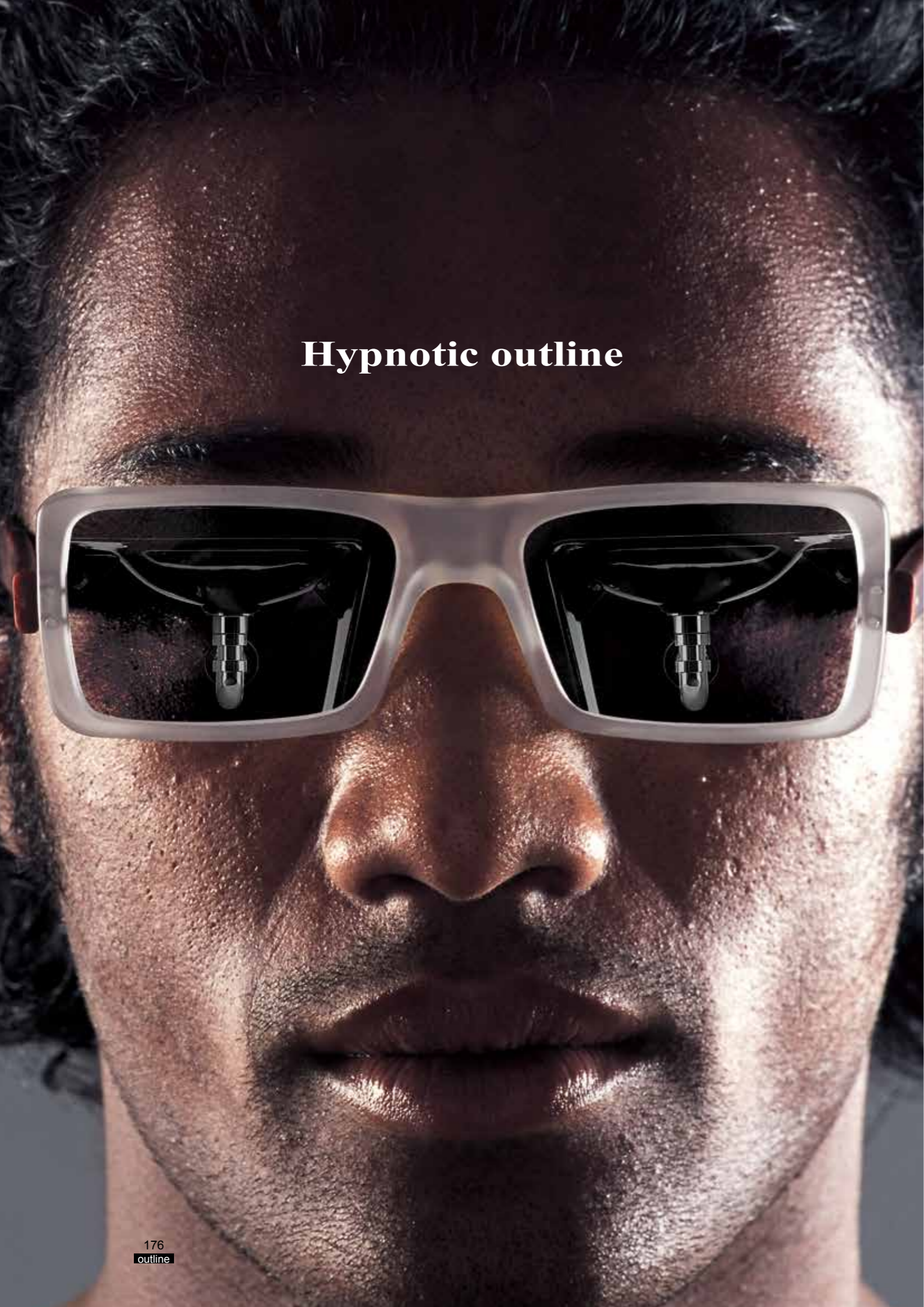

Red hot. passion

Quella che nel '500 Tiziano ritraeva come la Venere di Urbino, oggi spenderebbe una fortuna in creme anticellulite. La bellezza deve essere contemporanea.





Clonazione impossibile.

C'è un mondo tutto uguale
E c'è Outline.
Adesso non hai più scuse
per essere uguale.





Ci sono delle cose perfette,
ma finchè non parlano
all'immaginazione
non sono ancora belle.

piatto doccia **OUTLINE** si
abbina solo a
gusti unici





Welcome to the colours
easychicvintageglamourdecòcasualdesign

in una parola, Outline.
in one word, Outline.
en una palabra, Outline.

Tanti abbinamenti
 di colore per Outline:
 bianco-bianco
 nero-nero
 bianco-lemon
 bianco-cherry
 bianco-nero
 bianco-verde
 lemon-lemon
 bianco-bijoux
 nero-bijoux

Many colour
 combinations for Outline:
 white-white
 black-black
 white-lemon
 white-cherry
 white-black
 white-green
 lemon-lemon
 white-bijoux
 black-bijoux

Muchac combinaciones
 de colores para Outline:
 blanco-blanco
 negro-negro
 blanco-lemon
 blanco-cherry
 blanco-negro
 blanco-verde
 lemon-lemon
 blanco-bijoux
 negro -bijoux



WHITE AND CHERRY



WHITE AND BLACK



WHITE AND LEMON



WHITE AND GREEN



WHITE



BLACK



WHITE AND BIJOUX



LEMON



BLACK AND BIJOUX



Lavabi

Washbasins - Lavabos

50

50X48



40037 white



70

70X48

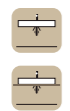

40038 white



90

90X48

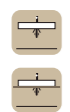

40039 white



Bidet

Bidet - Bidé

53

53X37

40035 white



53

53X37

40036 white



WC

WC - Inodoro

53

53X37

40031 white



53

53X37

40032 white



WC + Totem

WC + Totem - Inodoro + Totem

67

67X40

40031 white

+ 40203 white

40204 black



Consumo d'acqua
Water flush
Consumo de agua

Installazione:
Installation:
Instalación:

- Sospeso**
Wall hung
Suspendido
- Appoggio**
Sit on top
Apoyo
- Su colonna**
With pedestal
Con pedestal
- Sottopiano**
Under-counter
Bajoplano
- Semincasso**
Semirecessed
Bajo encimera
- Su mobile**
Cabinet basin
Con mueble

D-STYLE

Le sue linee morbide creano uno stile unico, accattivante, estroso e insolito.

Its soft lines create a unique, captivating and unusual style.

Sus líneas suaves crean un estilo único, cautivador, caprichoso e insólito.



D _ VINITY





D_IFFERENT

D_90



D — **UPPLICATE**





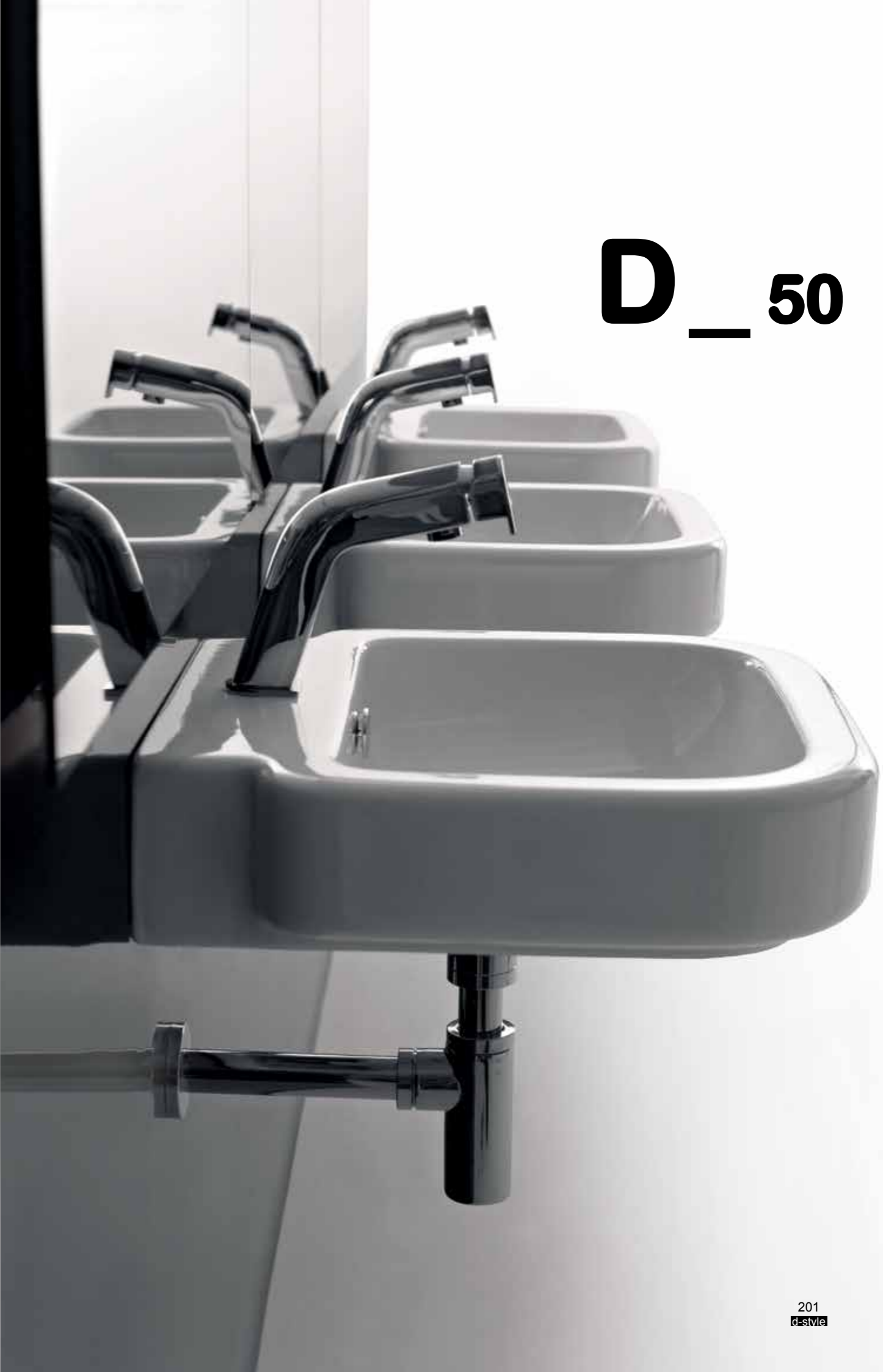

D_50





SIT D _ OWN

D _ Style & Totem Soft



Lavabi

Washbasins - Lavabos

48

48X37 COMPACT



40059 white
40061 black



40

40X40 CUBE



40050 white
40052 black



65

65X40 MEDIUM



40053 white
40055 black



100

100X40 LARGE



40056 white
40058 black



Bidet sospeso + Base

Wall hung bidet + Double system base - Bidé suspendido + Base

48

48X37

40059 white
40061 black
+
40070 white
40072 black
40071 yellow
40074 green
40073 cherry



Bidet sospeso

Wall hung bidet - Bidé suspendido

48

48X37

40059 white
40061 black



WC sospeso + Base

Wall hung WC + Double system base - Inodoro suspendido + Base

48

48X37

40062 white
40064 black
+
40070 white
40072 black
40071 yellow
40074 green
40073 cherry



WC sospeso

Wall hung WC - Inodoro suspendido

48

48X37

40062 white
40064 black



WC sospeso + Base + Totem

Wall hung WC + Double system base + Totem - Inodoro suspendido + Base + Totem

62

62X40

40062 white
40064 black
+
40070 white
40072 black
40071 yellow
40074 green
40073 cherry
+
40201 white
40202 black



Consumo d'acqua
Water flush
Consumo de agua

Installazione:
Installation:
Instalación:



Sospeso
Wall hung
Suspendido



Appoggio
St on top
Apoyo



Su colonna
With pedestal
Con pedestal



Con piedini
With legs
Con patas



Sottopiano
Under-counter
Bajo encimera



Semincasso
Semi recessed
Semiencastré



Su mobile
Cabinet basin
Con mueble

— COMPONENTS + SOLUTIONS =

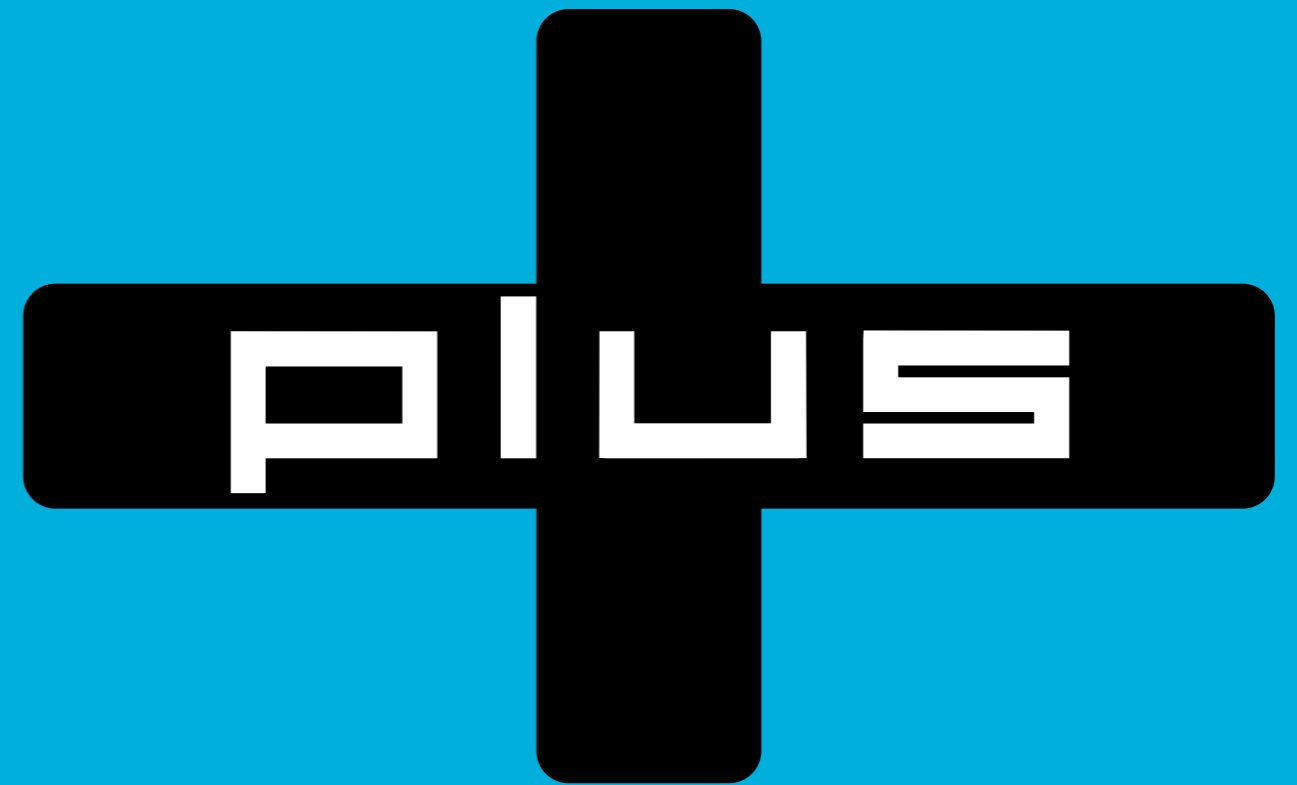



WHAT IS IT

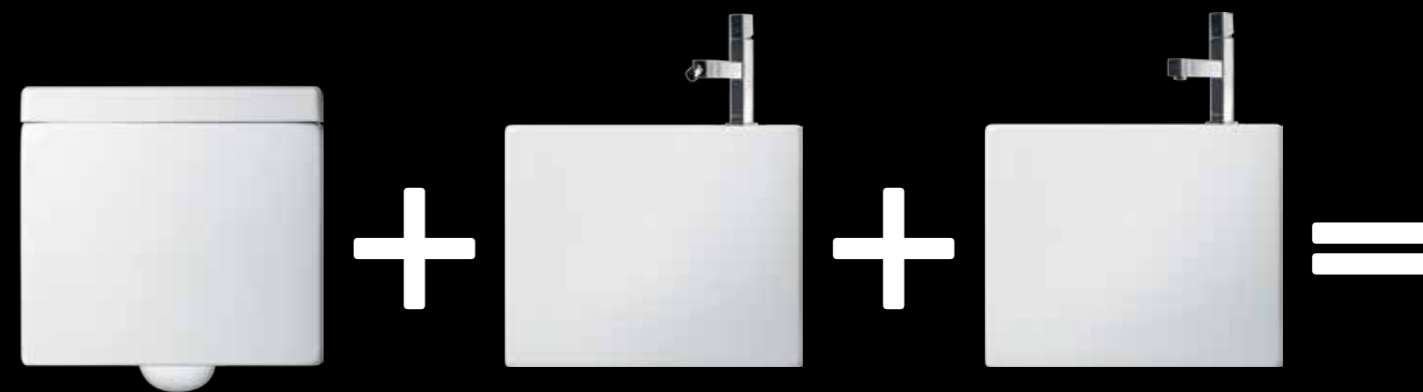

W.C. SOSPESO

BIDET SOSPESO

LAVABO





W.C. SOSPESO



BIDET SOSPESO

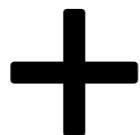
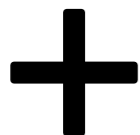

BASE DOUBLE SYSTEM



BASE DOUBLE SYSTEM





TOTEM HARD



W.C. SOSPESO



BASE DOUBLE SYSTEM



Il progetto Plus è la pura espressione del concetto di versatilità che si esprime nel minimalismo delle forme e nell'essenzialità dei materiali, creando infinite soluzioni per un ambiente bagno dinamico, giovane e soprattutto funzionale. I sanitari della collezione Plus, rappresentano un sistema del tutto innovativo. Con l'accostamento di più elementi si ottengono diverse soluzioni; aggiungendo una BASE di ceramica, disponibile in diversi colori, WC e BIDET, realizzati nella versione sospesa, si trasformano nella versione A TERRA. L'abbinamento di WC e BASE con l'elemento TOTEM da vita alla versione MONOBLOCCO.

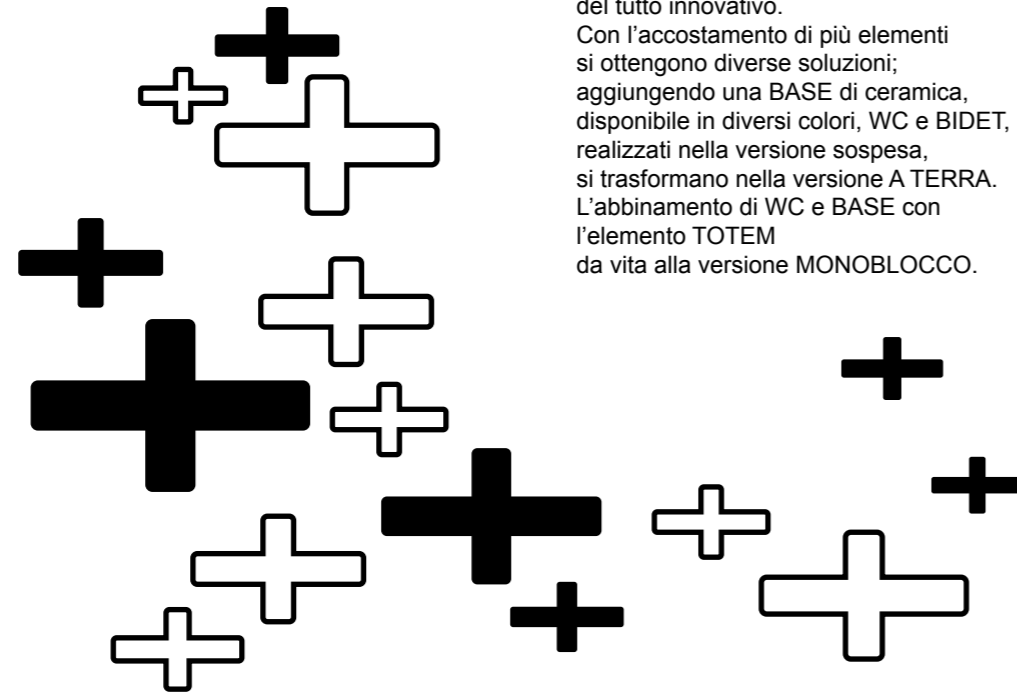

The "Plus" project is the pure expression of the concept of versatility expressed in the minimalism of its forms and the essentiality of materials, giving life to an infinite number of solutions for a dynamic bathroom environment, young and above all functional.

The sanitary ware of the "Plus" collection represents a totally innovative system. The combination of various elements gives life to various solutions; by adding a ceramic BASE of different colours, the wall hung W.C and BIDET are transformed into FLOOR sanitary ware.

The combination of the W.C. and the BASE together with the TOTEM element gives life to the CLOSE - COUPLED version.

El proyecto Plus es la pura expresión del concepto de versatilidad, que se expresa en el minimalismo de las formas y en la esencialidad de los materiales, dando vida a infinitas soluciones para un ambiente baño dinámico, joven y sobre todo funcional.

Los sanitarios de la colección Plus, representan un sistema absolutamente innovador. La combinación de diferentes elementos genera distintas soluciones; añadiendo una BASE en cerámica, disponible en varios colores, el INODORO y el BIDÉ, en su versión suspendida, se convierten en la versión AL SUELO.

La combinación de INODORO y BASE con el elemento TOTEM, origina la versión PARA TANQUE BAJO.



plus CUBE



CUBE



MEDIUM



LARGE







MEDIUM



LARGE





LAVABO



MOBILE SOSPESO







Lavabi

Washbasins - Lavabos

60

60X57 KONO
31021 white
30420 black



52

52X52 CORNER
31009 white



44

44X53 CENTER
31074 white

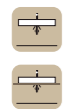

70

70X53 DUE
31008 white



78

78X53 UNO DX
31010 white



78

78X53 UNO SX
31011 white



Bidet

Bidet - Bidé

53

53X39
31040 white



50

50X39
31042 white



WC

WC - Inodoro

53

53X39
31004 white



50

50X39
31051 white



WC Monoblocco

Close-coupled WC - Inodoro para tanque bajo

63

63X39
31001 white
+
40128 white/31014 white



WC + Totem

WC + Totem - Inodoro + Totem

67

67X40
31004 white
+
40201 white
40202 black



Installazione:
Instalación:



Sospeso
Wall hung
Suspendido



Appoggio
Sit on top
Apoyo



Su colonna
With pedestal
Con pedestal



Con piedini
With legs
Con patas



Sottopiano
Under-counter
Bajo encimera



Semincasso
Semi recessed
Semiencastré



Su mobile
Cabinet basin
Con mueble

HERA

Gli stili di vita cambiano. E il concept del bagno con loro per ideare tendenze libere dai formalismi: la salle de bains si proietta nel resto della casa, esibendo, con discrezione, la propria eleganza. In sintonia con il proprio modo di vivere, il regno delle acque diventa l'ambiente dove rigenerarsi, complici progetti su misura del sé. Volumi compatti e accostamenti raffinati di materiali sapientemente selezionati sfociano in un'espressività d'avanguardia e in soluzioni ergonomicamente studiate, connotate da un design "trasgressivo".

Lifestyles change. And the bathroom concept with them in order to conceive trends free from formalisms: la salle de bains projects itself in the rest of the house, exhibiting, with discretion, its elegance. In harmony with your own way of living, the reign of water becomes the place in which to regenerate oneself, thanks to projects made to measure.

Compact volumes and refined material combinations wisely selected, develop into avanguard expressiveness and in solutions ergonomically studied, characterized by a "transgressive" design.

Los estilos de vida cambian. Y la concepción del baño cambia con éstos para idear tendencias sin formalismos: el cuarto de baño se proyecta en el resto de la casa, exhibiendo, con discreción, su elegancia. En sinergia con tu propio modo de vivir, el reino de las aguas se convierte en lugar regenerador, con la complicidad de proyectos que te corresponden perfectamente.

Volumenes compactos y acercamientos refinados de materiales elegidos con esmero desembocan en una expresividad de vanguardia y en soluciones ergonómicamente estudiadas, caracterizadas por un diseño "transgresivo".





Facciamo di tutto per non passare inosservati. Anche voi, originalissimi nelle forme. Semisospesi, i sanitari Hera facilitano le operazioni legate all'igiene. Due risoluzioni di colore permettono di uniformare la cifra stilistica, abbinando cromaticamente il coprivaso e la punta del cono.

We do our utmost in order not to pass unnoticed. You too, very original in shape. Half wall hung, the Hera sanitary ware simplifies the operations connected to hygiene. Two colour solutions allow us to unify style, chromatically combining the seat cover with the head of the cone support.

Dispuestos a todo con tal de no pasar inadvertidos. Vosotros también, originalísimos en las formas. Semi suspendidos, los sanitarios Hera agilizan las operaciones de limpieza. Dos soluciones de color permiten dar uniformidad estilística combinando cromáticamente el asiento y la base del cono.



Hera è una linea basata sul valore dell'oggetto che riflette uno stile di vita: la cura dei dettagli, le forme importanti ma sobrie ed infinite idee per progettare il bagno. Disponibili anche nella versione a terra, i sanitari mantengono intatta tutta la loro capacità del bacino e sono abbinabili flessibilmente con gli altri lavabi della collezione.

Hera is a range based on the value of the object which reflects a life style: the care for detail, the important yet sober shapes and neverending ideas in bathroom design. Also available in the back to wall version, the sanitary ware maintains intact all its basin capacity and can be combined with the other washbasins of the collection.

Hera es una línea que se centra en el valor del objeto que refleja un estilo de vida: el cuidado hacia los detalles, las formas importantes pero sobrias, e infinitas ideas para proyectar el baño. Disponibles también en el modelo al suelo, los sanitarios mantienen intacta toda la capacidad de su seno y pueden combinarse flexiblemente con los demás lavabos de la colección.

HERA CENTER Citazioni da un'architettura ipermoderna. E il lavabo da elemento strutturale, diventa presenza scenografica.





Effetto Hera anche se gli ambienti non sono maxi. Le soluzioni salvaspazio mantengono inalterato il comfort e garantiscono funzionalità.

Perché rinunciare quando ti posso avere?

The Hera effect works even if the room is not spacious. The space saver solutions maintain unchanged comfort and guarantee functionality.

Why then do without you, if I can have you?

Efecto Hera incluso cuando no se trata de entornos espaciosos. Las soluciones salva espacio mantienen inalterado el confort y garantizan funcionalidad.

¿Por qué renunciar cuando puedo contar contigo?





WC + TOTEM



CLOSE - COUPLED WC



HERA UNO Non chiamatemi piccola, non chiamatelo piccolo. Hera Uno è anche il comfort di un piano laterale.



Ritmo compositivo perfettamente simmetrico
per allestimenti a due. Anche se è il mio
momento, non voglio rinunciare a stare
insieme a te.

Composive rhythm perfectly symmetric for
twin combinations. Although it's my moment,
I don't want to do without you.

Ritmo compositivo perfectamente simétrico
para disposiciones a dos. Aunque es mi
momento, no quiero estar lejos de ti.





HERA CORNER

Dove gli altri non possono trovare posto, Hera Corner assicura comfort. Il lavabo, ad angolo, si inserisce negli spazi piú difficili.

Even in the smallest spaces, Hera Corner assures comfort. The corner basin fits in the most difficult spaces.

Donde los demás no llegan, Hera Corner asegura confort. El lavabo, angular, consigue introducirse en los espacios más difíciles.

Lavabi

Washbasins - Lavabos

40

40X40 NEO



30117 white
30144 black
30142 yellow
30143 grey
30141 cherry



40

40X40 KALI



30118 white
30149 black
30147 yellow
30148 grey
30146 cherry



40

40X40 TECNO



30119 white
30154 black
30152 yellow
30153 grey
30151 cherry



Piastre Elle

Elle slab counters - Encimeras Elle

100

100X50



30121 white
30164 black



120

120X50



30122 white
30169 black



120

120X50



30123 white
30174 black



140

140X50



30124 white
30179 black



140

140X50



30125 white
30184 black



180

180X50



30126 white
30189 black



Mensole di ceramica

Ceramic shelves - Repisas en cerámica

50

50X45

30100 white
30313 black
30311 yellow
30312 grey
30310 cherry



60

60X45

30102 white
30319 black
30317 yellow
30318 grey
30316 cherry



100

100X45

30101 white
30325 black
30323 yellow
30324 grey
30322 cherry

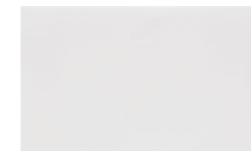

Installazione:
Installation:
Instalación:



Sospeso
Wall hung
Suspendido



Appoggio
Sit on top
Apoyo



Su colonna
With pedestal
Con pedestal



Con piedini
With legs
Con patas



Sottopiano
Under-counter
Bajo encimera



Semincasso
Semi recessed
Semiencastré



Su mobile
Cabinet basin
Con mueble



ELLE

Con Elle ci siamo superati, creando qualcosa che nessuno, fino ad oggi, era riuscito a fare. Piani dalle dimensioni così importanti che, grazie a soluzioni tecniche, ancoriamo alle pareti in tutta sicurezza. Piastre, fuori dall'ordinario, anche per la scelta del materiale con cui sono realizzate: una ceramica di ottime qualità capace di assicurare ampi margini di igiene. Elle è fatto di geometrie pulite, sobri accostamenti, libertà compositiva, versatilità: intorno alle diverse basi si avvicendano Kali, Tecno e Neo, lavabi dalle forme e misure diverse, personalizzabili anche nel colore: white, yellow, cherry, grey, black. Non solo: Elle è uno strumento di progettazione completo, potenzialmente estendibile all'infinito. Tali caratteristiche rendono la collezione ideale per fornire soluzioni anche per spazi pubblici.

We have really surpassed ourselves with Elle, creating something that no one else has ever done before. Counters of such considerable size that, thanks to technical solutions, we can securely anchor to the wall. Counters which are out of the ordinary thanks, among other things, to the quality of the material used: top quality ceramic capable of ensuring the very highest levels of hygiene. Elle comprises clear-cut shapes, low-key combinations, freedom of arrangement and versatility: the various bases are accompanied by Kali, Tecno and Neo, washbasins in a range of shapes and sizes, which can be customised in white, yellow, cherry, grey, black. But there's more: Elle is a complete design tool with infinite potential for extension. These features make it the ideal collection for public bathrooms too.

Con Elle nos hemos superado, creando algo que nadie, hasta hoy, había conseguido hacer. Planos con dimensiones tan importantes que, gracias a soluciones técnicas, anclamos a las paredes con completa seguridad. Placas, fuera de lo común, también para la elección del material con el que se realizaron: una cerámica de óptima calidad que asegura amplios márgenes de higiene. Elle destaca por sus geometrías límpidas, combinaciones sobrias, libertad de composición, versatilidad. Alrededor de las diversas bases se alternan Kali, Tecno y Neo, lavabos con formas y medidas diferentes, que se pueden personalizar también en el color: white, yellow, cherry, grey, black. Y lo que es más: Elle es un instrumento de proyección completo, potencialmente extensible al infinito. Estas características hacen que la colección sea ideal también para ofrecer soluciones a los espacios públicos.

...Sono stufo di uno stile senza anima. E anche nella sala da bagno voglio pezzi forti capaci di comunicare il mio mondo.



...una cromia inedita, lucidissima e glamour.
Perché rifugiamo gli ambienti anonimi.

...a brand new colour combination, glossy and
glamorous. No more anonymous environments.

...un cromatismo inédito, lúcido y fascinante.
Porque evitamos los ambientes anónimos.



Per il nostro bagno abbiamo scelto un blocco attrezzato con Tecno, in versione semicolonna.



Elegante minimalismo fatto di eccezioni, grafismi leggeri, invenzioni guidate dalla propria personalità.

Elegant minimalism made up of exceptions, light graphics, inventions inspired by the individual personality.

Elegante minimalismo hecho de excepciones, grafismos simples, invenciones guiadas por la propia personalidad.

Non mi accontento, lo so... Ma tu mi capisci perfettamente e, con le tue linee pulite, ti adatti a qualsiasi location, anche quelle più originali.

Fammi ritrovare il ritmo della natura, assottigliando il confine tra interno ed esterno.

I am difficult to please, I know...but you understand me perfectly and, with your clean style, you adapt perfectly to every location, even the most original.

Help me fall back into step with nature, narrowing the gap between indoors and out.

No quiero contentarme, ya lo sé... Sin embargo tú me entiendes perfectamente y, con tus líneas límpidas, te adaptas a cualquier sitio, hasta los más originales.

Hazme encontrar el ritmo de la naturaleza, afinando el confín entre interior y exterior.



ELLE 120 DUO + CONSOLLE + KALI BLACK





ELLE 120 + MOBILE SOSPESO + NEO CHERRY

Cherry up-to-date traduce il mio mood.

268
elle



Non solo ceramica.
La serie Elle si coordina con elementi
d'arredo sobri, creando zone
dove soggiornare e avere cura di sé.

Not just ceramics.
The Elle series coordinates with
simple furnishing elements, creating
places in which to spend
time and take care of oneself.

No sólo cerámica.
La serie Elle se coordina con elementos
de decoración sobrios, creando zonas donde habitar
y cuidar del aspecto personal.



269
elle



Quasi un colpo di fulmine tra il rosso Neo Cherry e il candidissimo piano Elle. Tubature in vista come richiedono le tendenze più glam.

Almost love at first sight between Neo Cherry and the pure Elle counter. Visible pipes in keeping with the most glam trend.

Casi un flechazo entre el rojo Neo Cherry y el candidísimo plano Elle. Tubos a la vista como exigen las tendencias más glam.



ELLE 100 + NEO CHERRY

Potrei incantarmi, quando guardo il tuo profilo square.



Lavabo

Washbasin - Lavabo

50

50X36



- 30076 white
- 30301 black
- 30303 yellow
- 30302 cherry



P. 422

Installazione:
Installation:
Instalación:



Sospeso
Wall hung
Suspendido



Appoggio
Sit on top
Apoyo



Su colonna
With pedestal
Con pedestal



Con piedini
With legs
Con patas



Sottopiano
Under-counter
Bajo encimera



Semincasso
Semi recessed
Semiencastré



Su mobile
Cabinet basin
Con mueble

EASY SMALL

Lo stile nei piccoli spazi. E' Easy Small.
Il lavabo compatto, funzionale, innovativo è
presentato in un'ampia gamma di cromie diverse.
Composto da un unico blocco di ceramica non
rinuncia al comfort con il ripiano portaoggetti e i
portasalviette laterali in acciaio. Così concepito,
Easy Small può trovare un'originale collocazione
anche in ambienti diversi da quelli più legati alla
privacy. Easy Small è la rivisitazione in chiave
moderna dell'antico catino.
Le sue dimensioni lo rendono ideale anche nel
settore del contract.

For style in small spaces. It's Easy Small.
The compact, functional, innovative washbasin is
presented in a wide range of colours. Composed
of a single ceramic block, it is not lacking in
comfort with its shelf and lateral steel towel bars.
So conceived, Easy Small is able to find an original
place for itself, even in settings which are not
usually those associated with the privacy
of the bathroom. Easy Small is the revisitation of the old
basin in a modern key.
Its dimensions also make it ideal in the contract
sector.

El estilo en los espacios pequeños.
Esto es Easy Small.
El lavabo compacto, funcional, innovador, se
presenta en una amplia gama de colores
diferentes.
Constituido por un bloque único de cerámica no
quiere renunciar al confort y se dota de la repisa
para objetos y de los toalleros laterales en acero.
Así concebido Easy Small puede encontrar una
original colocación también en ambientes
diferentes de los que normalmente se asocian a la
privacidad. Es el remake en sentido moderno de la
antigua palangana.
Sus dimensiones lo hacen ideal incluso en el sector
del contract.





EASY SMALL

C'è un nuovo modo di vedere il bagno.





La magia del totalblack.

Easy Small è tutto di un pezzo e si installa facilmente anche negli ambienti non propriamente suoi, diventando protagonista anche nella zona notte.

The magic of totalblack.

Easy Small is one single element easy to install even in settings which are not exactly its own, thereby becoming protagonist even in the night zone.

La magia del todo negro.

Easy Small es una pieza única y se instala fácilmente también en aquellos ambientes que no le pertenecen, convirtiéndose en protagonista incluso de la zona noche.

Lavabi

Washbasins - Lavabos

60

60X60

ROYAL



30353 white
40769 black



56

56X45

ROYAL



30354 white
40770 black



63X32

27030 white
40848 black



70

70X59

ROYAL



27021 white
40771 black



63X32

27030 white
40848 black



85

85X45

CONSOLLE 85



30355 white
40772 black



83X12

40408 white
40787 black
40788 platinum
40789 gold



105

105X45

CONSOLLE 105



40127 white
40773 black



83X12

40408 white
40787 black
40788 platinum
40789 gold



110

110X61

CONSOLLE 110



40129 white
40774 black



83X12

40408 white
40787 black
40788 platinum
40789 gold



110

110X55

CALIPSO



30060 white
40775 black



75X12

40191 white
40793 black
40794 platinum
40869 gold



Bidet

Bidet - Bidé

57

57X36



27040 white
40776 black



WC

WC - Inodoro

55

55X36



27003 white
40777 black



27004 white
40778 black



WC + Cassetta a zaino

WC + Low cistern - Inodoro + Tanque media altura

55

55X36

17

17X47



27003 white
40777 black
+
40288 white
40783 black



27004 white
40778 black
+
40288 white
40783 black



WC Monoblocco

Close-coupled WC - Inodoro para tanque bajo

70

70X47



27001 white
40779 black
+
27014 white
40781 black



27002 white
40780 black
+
27014 white
40781 black



WC + Cassetta alta

WC + High cistern - Inodoro + Tanque alto

55

55X47

17

17X47



27003 white
40777 black
+
27013 white
40782 black



27004 white
40778 black
+
27013 white
40782 black



Vasca

Bathtub - Bañera

170

170X80

40859 white/chrome metal feet
40860 white/white metal feet
40861 white/bronze metal feet
40862 white/gold metal feet

Kit colonna scarico e sifone - Drain column and siphon kit - Tubo de descarga
40863 chrome metal kit
40864 white metal kit
40865 bronze metal kit
40866 gold metal kit



Consumo d'acqua
Water flush
Consumo de agua

Installazione:
Installation:
Instalación:



Sospeso
Wall hung
Suspendido



Appoggio
Sit on top
Apoyo



Su colonna
With pedestal
Con pedestal



Con piedini
With legs
Con patas



Sottopiano
Under-counter
Bajo encimera



Semincasso
Semi recessed
Semiencastré



Su mobile
Cabinet basin
Con mueble

Royal

Al fondo di tutto c'è una regola, una misura, un progetto guida che di volta in volta cambia. Royal è un programma di lavabi e sanitari esclusivi ed importanti, disponibili in un'articolata gamma di soluzioni e dimensioni. Un sistema che recupera il passato, rinnovandolo nell'ottica del comfort moderno.

Histoire d'eau



Behind everything there is a rule, a measure, a master design that changes each time. Royal is a range of exclusive washbasins and fittings available in an articulate series of solutions and dimensions. A system that renews the past with a view to modern comfort.

En el fondo de todo hay una regla, una medida, un proyecto que guía y que cambia de vez en cuando. Royal es un programa de lavabos y sanitarios exclusivos e importantes, disponible en una amplia gama de soluciones y dimensiones. Un conjunto que rescata el pasado, renovándolo en línea con el confort moderno.





Royal 70

Cambiare, significa innovare, anche negli ambienti retrò. Significa anche inventare uno stile, optando per pezzi classici, monocolori, liberamente abbinabili fra loro.

Change means innovation also in "retrò" environments. It also means inventing a style, opting for classic pieces, mono-colours, which can be easily matched.

Cambiar significa innovar, incluso en los ambientes "retrò". Significa también inventar un estilo, optando por piezas clásicas, monocromáticas, libres de combinarse entre ellas.

Se la cifra stilistica
cita il passato,
l'effetto
globale è di una
rarefatta
contemporaneità.

Giochi di curve creati da
una linea compiacente.
E le forme scultoree
sfoggiano una luminosità
dilagante.

The play of curves created
by this line.
And the sculptured forms
display luminosity.

Juegos de curvas
caracterizados por una
línea complaciente.
Y las formas-esculturas
lucen una brillantez que
se propaga.

Royal 70





Tributo alla classicità.

Il lavabo è un piccolo tempio
dedicato all'acqua.



Calipso

La magia della luce e il fascino irresistibile di un bagno d'epoca fanno riscoprire il piacere dell'acqua.

The magic of light and the irresistible appeal of a period bathroom rediscover the pleasures of water.

La magia de la luz y el encanto irresistible de un baño de época descubren de nuevo el placer por del agua.



La sala da bagno Royal.



Un'eleganza che coniuga
modernità e classicità.

An elegance that combines
modernity and classicism.

Una elegancia que combina
modernidad y clasicismo.



Consolle 110

Profili raffinati ed eleganti danno vita
alla collezione di Consolle Royal.
Nella foto a destra la Consolle 110,
classica, ma fresca ed attuale.

Refined and elegant profiles give life
to the collection of "Royal Consolle".
In the right hand picture you can see
the "Console 110",
classic, but fresh and actual.

Perfiles refinados y elegantes le dan vida
a la colección de Consolas Royal.
En la foto de derecha la Consola 110,
clásica, pero fresca y actual.



Seduzione, lusso,
purezza, ma senza
entrare in conflitto
con la modernità
e la funzionalità.



Seduction, luxury and purity which does not clash
with modernity and functionality.

Seducción, lujo, pureza que no entran en conflicto
con la modernidad y la funcionalidad.





Dettagli oro e platino per impreziosire ancora di più la sala da bagno.

Gold and platinum details embellish the bathroom even more.

Detalles oro y platino para embellecer aún más el cuarto de baño.



Eleganza senza tempo.

Timeless elegance.

Elegancia atemporal..





Consolle 105





Royal 56 incasso



Royal Corner

Lavabi

Washbasins - Lavabos

70

70X61

ROSE

24021 white



65X28

24030 white



110

110X61

CONSOLLE 110

40129 white

40774 black



83X12

40408 white

40787 black

40788 platinum

40789 gold



110

110X55

CALIPSO

30060 white

40775 black



75X12

40191 white

40793 black

40794 platinum

40869 gold



Bidet

Bidet - Bidé

59

59X37



24040 white



WC

WC - Inodoro

57

57X38



24003 white



24004 white



WC Monoblocco

Close-coupled WC - Inodoro para tanque bajo

73

73X38



24001 white
+
24014 white



24002 white
+
24014 white



Consumo d'acqua
Water flush
Consumo de agua

Installazione:
Installation:
Instalación:



Sospeso
Wall hung
Suspendido



Appoggio
Sit on top
Apoyo



Su colonna
With pedestal
Con pedestal



Con piedini
With legs
Con patas



Sottopiano
Under-counter
Bajo encimera



Semincasso
Semi recessed
Semiencastré



Su mobile
Cabinet basin
Con mueble

Rose

Le grand eur

Le grandeur del passato si
traduce in forme che
risaltano come sculture.
E la ceramica dà il meglio di sé...

The grandeur of the past is
represented in forms which
stand out like sculptures.
It is ceramics at their best...

Le grandeur del pasado se
traduce en formas que
destacan como si fueran esculturas.
Y la ceramica ofrece lo mejor de si...





Consolle Calipso

Lo stile di Rose è fuori dal tempo: le sue proporzioni e le sue forme rendono l'intera serie un classico intramontabile, capace di sfidare le mode.

The Rose style is timeless: the proportions and the forms make this entire series a classic, capable of defying changing fashions.

El estilo de Rose está fuera del tiempo: sus proporciones y sus formas convierten todo el conjunto en un clásico que no decade y que puede desafiar a las modas.





Rose 70

Rose 70



Gusto compositivo e
ispirazione old time si
sintetizzano in tutti gli
elementi della collezione.

Neverending story

Compositive taste and
inspiration from times gone
by are synthesized in every
piece of this collection.

Gusto compositivo e
inspiración "old time" se
sintetizan en todos los
elementos de la colección.

C'è un modo più soft
di intendere la vita,
se c'è
un Rose.

There is a pleasanter way
of living when there is a
Rose.

Si hay un Rose, hay una
manera más soft de
entender la vida.





Rose

Scegliere un classico significa optare per una linea di lavabi e di sanitari articolata e coordinabile che permettono di creare un bagno personale e raffinato.

Choosing a classic means opting for a line of washbasins and fittings articulated and co-ordinable which allow us to create a refined and personalized bathroom.

Elegir un clásico significa optar por una línea de lavabos y de sanitarios variada, con posibilidad de coordinarse y de crear un baño personal y refinado.



Lavabi

Washbasins - Lavabos

60

60X39



40132 white
40206 black



80

80X39



40137 white
40205 black



100

100X39



40138 white
40207 black



Installazione:
Installation:
Instalación:



Sospeso
Wall hung
Suspendido



Appoggio
Sit on top
Apoyo



Su colonna
With pedestal
Con pedestal



Con piedini
With legs
Con patas



Sottopiano
Under-counter
Bajo encimera



Semincasso
Semi recessed
Semiencastré



Su mobile
Cabinet basin
Con mueble

sm art

basin collection





smart 100

332
lavabi smart

La gamma di lavabi Smart, risponde alle esigenze di un ampio target, grazie alle caratteristiche di funzionalità e tendenza. La profondità di soli 39 cm, li rende adatti anche agli spazi più piccoli, senza però rinunciare alla comodità, infatti la capienza della vasca e il piano d'appoggio laterale, ne agevolano l'utilizzo.

The Smart washbasins range meets the needs of a large target, thanks to its features that combine functionality and fashion. The depth of only 39 cm makes these washbasins also suitable for smaller spaces, without sacrificing comfort. Indeed the remarkable capacity of the basin and the lateral top in the 80 and 100 measures, facilitate their use.

La gama de lavabos Smart responde a las necesidades de un amplio target gracias a las características que combinan funcionalidad y tendencia. La profundidad de sólo 39 cm, hace estos lavabos idóneos incluso para los espacios más pequeños, sin sacrificar la comodidad. De hecho la notable capacidad del seno y el plano de apoyo lateral en las medidas 80 y 100 facilitan su propio uso.

333
lavabi smart

sm art 80

Volumi puri,
linee dolcemente stondate,
la composizione lavabo mobile
pensata per chi
non vuole rinunciare
ad un design ricercato
e vivere il proprio tempo in un
ambiente funzionale.

Pure volumes, gently rounded
lines, the composition of furniture
and washbasin designed for
those who don't wish to relinquish
sophisticated designs in order and
who wish to live their time
in a functional environment.

Volúmenes de líneas
puras, ligeramente redondeadas,
la composición del lavabo con
mueble pensada para aquellos
que no quieren renunciar a un
diseño sofisticado y a vivir su
tiempo en un ambiente funcional.

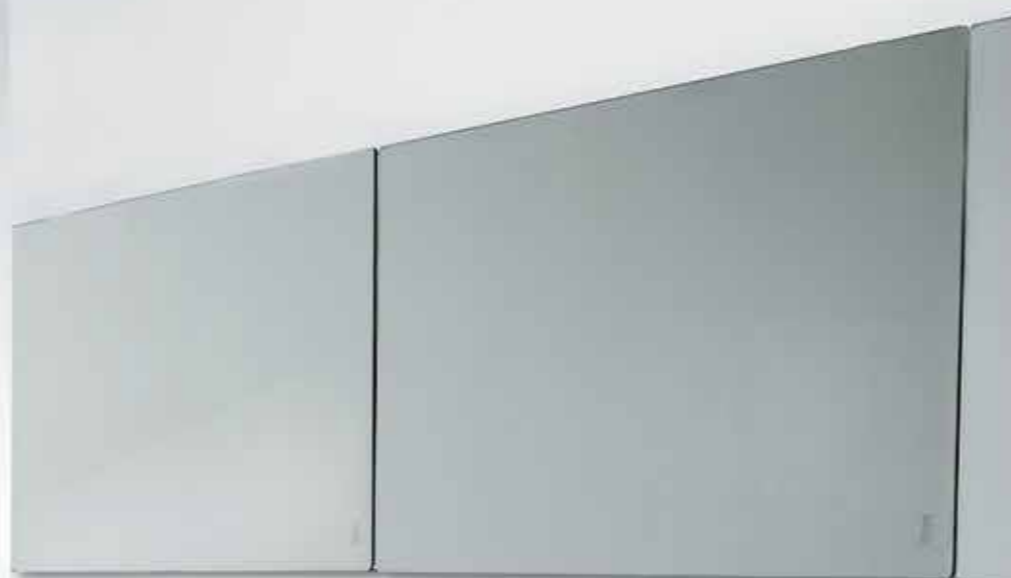



100



**bla
ck
&
wh
ite**



80



60





sm art 60

Versione nero integrale per i lavabi Smart 60, perfetti per combinazioni a due. Li vediamo abbinati ai sanitari sospesi Oceano e ai piatti doccia Ito da cm 120x75, anch'essi a due per vivere l'ambiente in coppia.

Total black version for the Smart 60, perfect for a combination to two. We see them combined with Oceano wall hung sanitary ware and with the Ito shower trays of 120x75, also in two, in order to live the environment as a couple.

Versión negro integral para los Smart de cm. 60, perfectos en combinaciones para dos. Los vemos combinados con los sanitarios suspendidos Oceano y con los platos de ducha Ito de 120x75 estos también para dos, para vivir el ambiente en pareja.



Soddisfa i tuoi sensi!
Corpo e anima si fondono
quando vivi un ambiente
capace di trasmetterti
tutto ciò di cui hai bisogno.

Satisfy your senses! Body
and soul come together when
you live in an environment
that transmits
everything you need.

Satisface tus sentidos!
Cuerpo y alma se unen
cuando vives en un ambiente
que puede transmitirte todo
lo que necesitas.

Lavabi

Washbasins - Lavabos

43

PROFONDITÀ
DEPTH - PROFUNDIDAD

61

61X43



40356 white



81

81X43



40357 white



101

101X43



40358 white



46

PROFONDITÀ
DEPTH - PROFUNDIDAD

61

61X46



40482 white

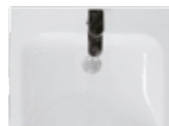

81

81X46



40483 white

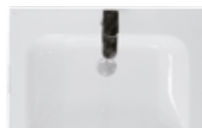

101

101X46



40484 white

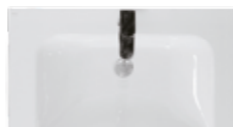

Installazione:
Installation:
Instalación:



Sospeso
Wall hung
Suspendido



Appoggio
St on top
Apoyo



Su colonna
With pedestal
Con pedestal



Con piedini
With legs
Con patas



Sottopiano
Under-counter
Bajo encimera



Semincasso
Semi recessed
Semiencastré



Su mobile
Cabinet basin
Con mueble

STILO 60



Stilo coniuga la versatilità di una superficie uniforme e lineare ad una valenza estetica. Queste caratteristiche rendono il lavabo Stilo capace di rispondere alle esigenze di un ampio target.

Stilo combines the versatility of a strong, smooth surface to an aesthetic value. This makes the Stilo washbasin capable of meeting the needs of a wide target.

Stilo asocia la versatilidad de una superficie uniforme y lineal con una valor estético. Estas características hacen que el lavabo Stilo sea capaz de responder a las exigencias de un amplio target.

STILO





STILO 100



funzionalità e tendenza

Stilo è protagonista indiscusso.
Funzionalità e tendenza
si mixano,
ideando soluzioni
per il bagno
che diventa living room.

Stilo is the undisputed protagonist.
Functionality and fashion
are mixed, creating
solutions for
the bathroom that
becomes a living room.

Stilo es el protagonista indiscutible.
Funcionalidad y tendencia se
mezclan creando soluciones
para un baño que se
transforma en una
verdadera sala de estar.

Lavabi Washbasins - Lavabos

52

52X33 ENJOY

30072 white



57

57X40 TIBEX

30074 white



22

22X40 SMALL

40216 white
40231 black
40847 grey
40233 platinum



50

50X48 NIKE

30056 white



60

60X39 SMART

40132 white
40206 black



80

80X39 SMART

40137 white
40205 black



100

100X39 SMART

40138 white
40207 black



61

61X43 STILO

40356 white



81

81X43 STILO

40357 white



101

101X43 STILO

40358 white



45

45X46 SALLY

30078 white



46

46X46 ROY

30097 white



50

50X45 STIK

30057 white



50

50X48 JOS

30055 white



50

50X50 JAZZ

31031 white



60

60X39 PRADO

30077 white



60

60X50 KATO

31029 white



70

70X50 NAKO

31028 white



80

80X50 CHEREL

30058 white



108

108X50 WELL DUE

30059 white



Installazione:
Installation:
Instalación:



Sospeso
Wall hung
Suspendido



Appoggio
Sit on top
Apoyo



Su colonna
With pedestal
Con pedestal



Con piedini
With legs
Con patas



Sottopiano
Under-counter
Bajo encimera



Semincasso
Semi recessed
Semiencastré



Su mobile
Cabinet basin
Con mueble

Lavabi Washbasins - Lavabos

40

40X40 NEO



30117 white
30144 black
30142 yellow
30143 grey
30141 cherry



40

40X40 KALI



30118 white
30149 black
30147 yellow
30148 grey
30146 cherry



40

40X40 TECNO



30119 white
30154 black
30152 yellow
30153 grey
30151 cherry



40

40X40 IN



31032 white



44

44X44 ON



31025 white



45

45X40 UKA



31034 white



50

50X40 OUT



31033 white



45

45X35 COVER



40582 white
40796 black
40799 yellow
40797 green
40795 cherry
40798 grey
40800 platinum



58

58X35 COVER



40234 white
40240 black
40243 yellow
40245 green
40242 cherry
40241 grey
40239 platinum



70

70X35 COVER



40583 white
40802 black
40805 yellow
40803 green
40801 cherry
40804 grey
40806 platinum



90

90X35 COVER



40584 white
40808 black
40811 yellow
40809 green
40807 cherry
40810 grey
40812 platinum



Installazione:
Installation:
Instalación:



Sospeso
Wall hung
Suspendido



Appoggio
St on top
Apoyo



Su colonna
With pedestal
Con pedestal



Con piedini
With legs
Con patas



Sottopiano
Under-counter
Bajo encimera



Semincasso
Semi recessed
Semiencastré



Su mobile
Cabinet basin
Con mueble

LAVABI D'ARREDO



In linea con il nuovo modo di abitare la casa.



nako

356
lavabi d'arredo



kato



357
lavabi d'arredo



Geometrie essenziali per questa collezione dal **design sobrio** e dalle **linee armoniose.**



Essential geometry for this collection with its simple design and graceful proportions.

Geometrías esenciales para esta colección con su diseño simple y sus líneas armoniosas.



out

360
lavabi d'arredo



uka

361
lavabi d'arredo



A design able to combine aesthetic contents with great functionality, offering a freedom of composition marked by a refined style.

Un diseño capaz de combinar contenidos estéticos con una extensa funcionalidad, ofreciendo una libertad de composición que guía hacia un estilo rebuscado.

Un design capace di abbinare forti **contenuti estetici** ad una grande **funzionalità**, offrendo una libertà compositiva improntata su uno **stile ricercato.**



on



roy



Elegante e discreto,
manifesta la sua **autenticità**
in un ambiente bagno
ancora più **essenziale.**

Elegant and discreet, it show its
authenticity in a bathroom
environment even more
essential.

Elegante y discreto,
demuestra su autenticidad en
un cuarto de baño aún más
esencial.





cherel

Una **vasta gamma** di lavabi dal **trend minimalista** per soddisfare le richieste di un mercato **sempre più esigente**.



A wide range of washbasins characterized by a minimalist trend in order to satisfy the requests of an increasingly demanding market.

Una amplia gama de lavabos de tendencia minimalista para satisfacer todas las demandas de un mercado cada vez más exigente.

jos

370
lavabi d'arredo



nike



371
lavabi d'arredo



sally

372
lavabi d'arredo



prado

Armonia di **linee** e **volumi**.



373
lavabi d'arredo



well 2

374

lavabi d'arredo

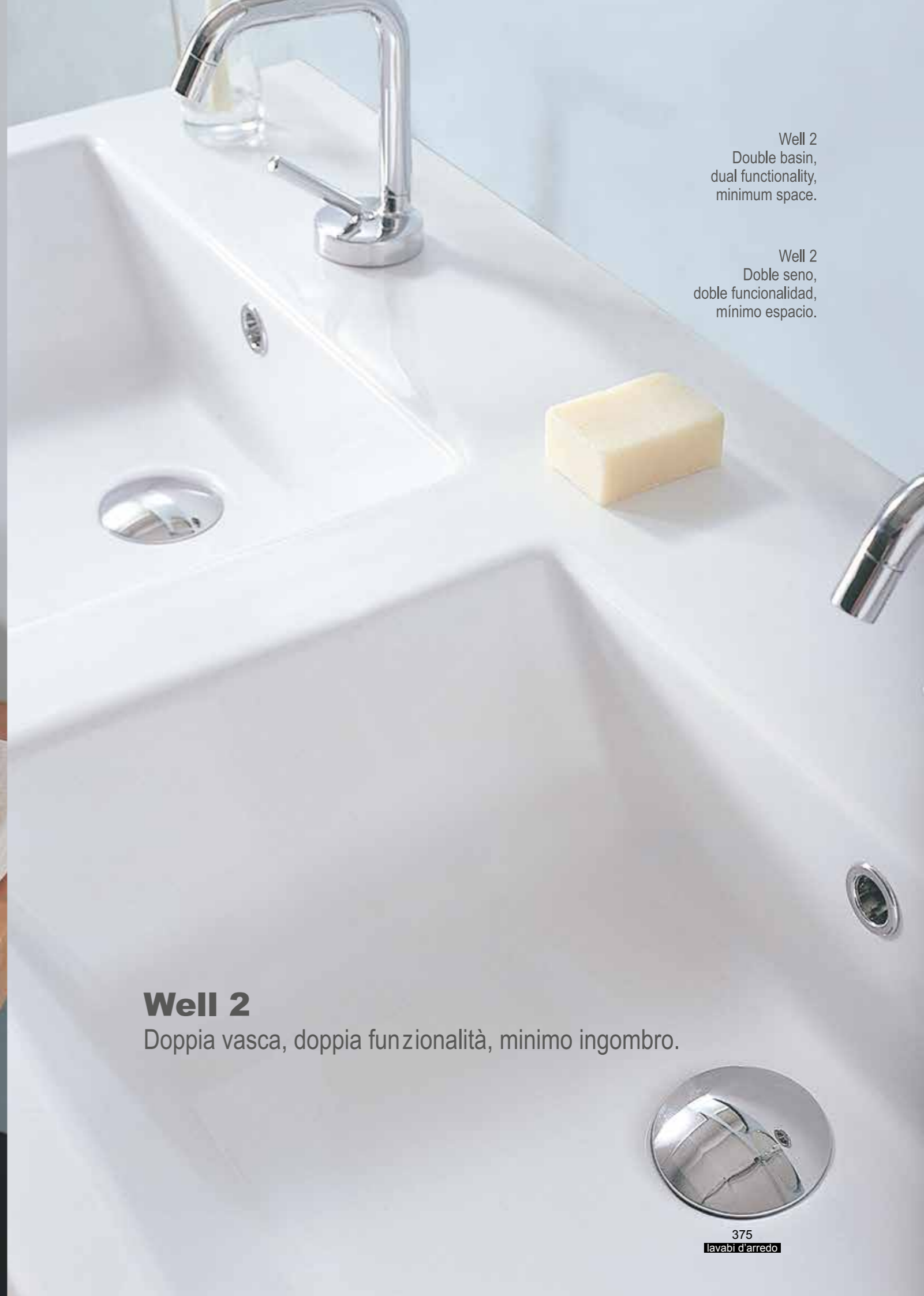

Well 2
Double basin,
dual functionality,
minimum space.

Well 2
Doble seno,
doble funcionalidad,
mínimo espacio.

Well 2

Doppia vasca, doppia funzionalità, minimo ingombro.

375

lavabi d'arredo

smart 100 80 60

La gamma di lavabi Smart, risponde alle esigenze di un ampio target, grazie alle caratteristiche di funzionalità e tendenza. La profondità di soli 39 cm, i rende adatti anche agli spazi più piccoli, senza però rinunciare alla comodità.

The Smart washbasins range meets the needs of a large target, thanks to its features that combine functionality and fashion. The depth of only 39 cm makes these washbasins also suitable for smaller spaces, without sacrificing comfort.

La gama de lavabos Smart responde a las necesidades de un amplio target gracias a las características que combinan funcionalidad y tendencia. La profundidad de sólo 39 cm, hace estos lavabos idóneos incluso para los espacios más pequeños, sin sacrificar la comodidad.



STILO

60
80
100

Stilo è protagonista indiscusso.
Funzionalità e tendenza
si mixano,
ideando soluzioni
per il bagno
che diventa living room.

Stilo is the undisputed protagonist.
Functionality and fashion
are mixed, creating
solutions for
the bathroom that
becomes a living room.

Stilo es el protagonista indiscutible.
Funcionalidad y tendencia se
mezclan creando soluciones
para un baño que se
transforma en una
verdadera sala de estar.





Il profilo sottile rende il Cover d'appoggio estremamente leggero ed elegante.

The reduced profile confers the sit on top Cover an extremely light and elegant aspect.

El perfil sutil hace el Cover de apoyo extremadamente ligero y elegante.



Lavabi

Washbasins - Lavabos

67

67X52



40867 white



66

66X56



40542 white



Accessori

Accessories - Accesorios

Staffa fissa di fissaggio lavabo
Fixed fixing bracket for washbasin
Fijación fija para lavabo
40544



Staffa con regolazione pneumatica
Fixing bracket with pneumatic regulation
Fijación con regulación neumática
40545



Maniglione
Grab rail
Asa de baño recta

L.30 D2 L.40 D2.1 L.50 D2.2
L.60 D2.3 L.90 D2.4



Barra di sostegno ribaltabile cm 80
Cm 80 fold up grab rail
Asa de sujeción abatible cm 80
D3



Barra di sostegno ribaltabile con porta rotolo
Cm 80 fold up grab rail with toilet tissue dispenser
Asa de sujeción abatible con porta rotolo cm 80
D3.1



Barra di sostegno con rinforzo dx o sx cm 80
Cm 80 left or right hand reinforced grab rail
Asa de sujeción con refuerzo dcha o izqda cm 80
D4



Seggiolino ribaltabile fisso per doccia
Fixed fold up shower seat
Asiento abatible fijo para ducha
D11.1



Sedile ribaltabile asportabile per doccia
Fold up portable shower seat
Asiento abatible y extraíble para ducha
D11



Copribordo in termoformato per wc disabili
Removable plastic toilet seat for disabled wc
Aro para inodoro termoformado de fácil accesibilidad
40543



WC - Bidet Comfort

Comfort Wc-Bidet - Inodoro-Bidé Comfort

52

52X37

40853 white



52

52X37

40854 white



WC Comfort

Comfort WC - Inodoro Comfort

52

52X37

40851 white



52

52X37

40852 white



Wc - Bidet Comfort con apertura

Comfort Wc-Bidet with front aperture - Inodoro-Bidé Comfort con apertura

52

52X37

40855 white



52

52X37

40856 white



WC Comfort con apertura

Comfort WC with front aperture - Inodoro Comfort con apertura

50

50X38

40534 white



50

50X38

40535 white



Installazione:
Installation:
Instalación:



Sospeso
Wall hung
Suspendido

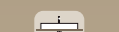

Appoggio
Sit on top
Apoyo

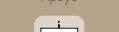

Su colonna
With pedestal
Con pedestal

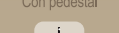

Con piedini
With legs
Con patas

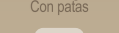

Sottopiano
Under-counter
Bajo encimera

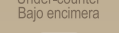

Semincasso
Semi recessed
Semiencastré

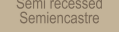

Su mobile
Cabinet basin
Con mueble

Lavabo Comfort cm 66

Comfort basin cm 66
Lavabo Comfort



WC Comfort

Comfort WC
Inodoro Comfort



WC - Bidet Comfort

Comfort WC - Bidet
Inodoro - Bidé Comfort



Lavabo Comfort cm 67

Comfort basin cm 67
Lavabo Comfort cm 67



WC Comfort con apertura

Comfort WC with front aperture
Inodoro Comfort con apertura



WC - Bidet Comfort con apertura

Comfort WC - Bidet with front aperture
Inodoro - Bidet Comfort con apertura

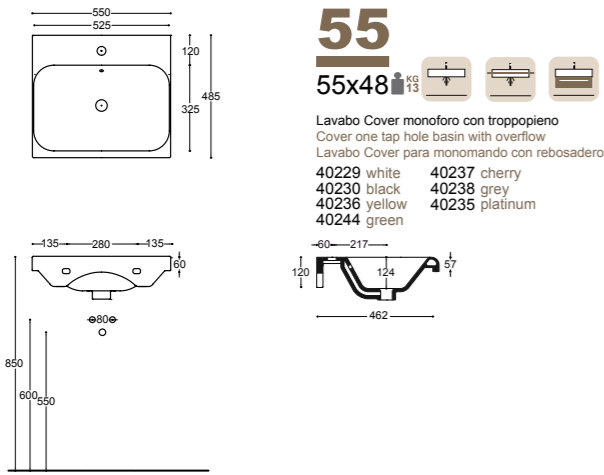

**55****55x48**

Lavabo Cover monoforo con troppopieno
Cover one tap hole basin with overflow
Lavabo Cover para monomando con rebosadero

40229 white 40237 cherry
40230 black 40238 grey
40236 yellow 40235 platinum
40244 green

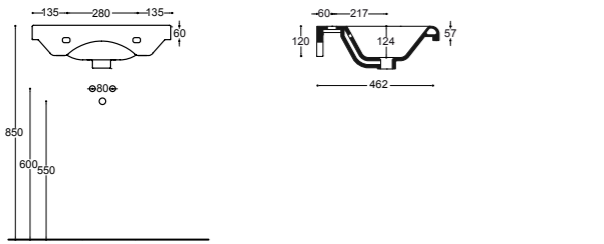
**70****70x48**

Lavabo Cover monoforo con troppopieno
Cover one tap hole basin with overflow
Lavabo Cover para monomando con rebosadero

40310 white 40318 green
40316 black 40314 cherry
40312 yellow 40319 grey

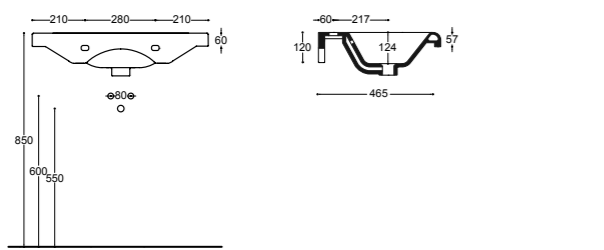
**80****80x48**

Lavabo Cover monoforo con troppopieno
Cover one tap hole basin with overflow
Lavabo Cover para monomando con rebosadero

40320 white 40325 green
40324 black 40322 cherry
40321 yellow 40326 grey

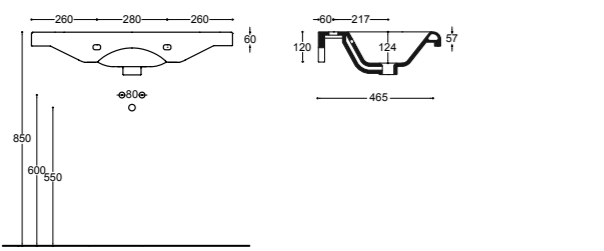
**80****80x48**

Lavabo Cover monoforo con troppopieno
Cover one tap hole basin with overflow
Lavabo Cover para monomando con rebosadero

40313 white 40346 green
40344 black 40345 cherry
40342 yellow 40347 grey

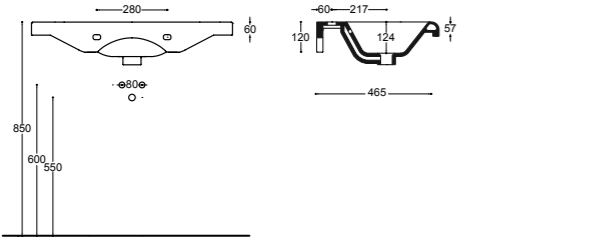

386

cover

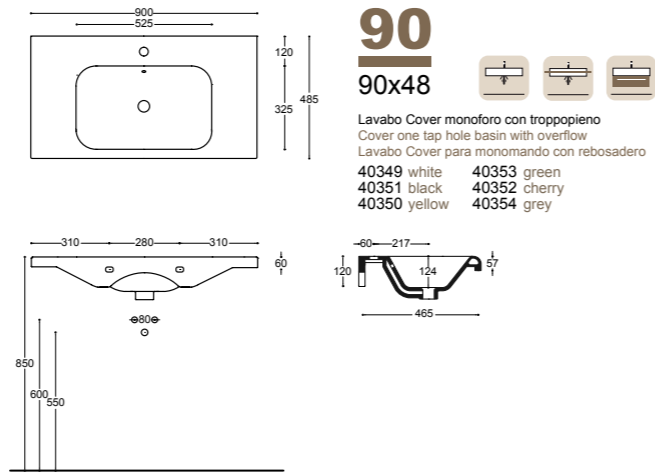
**90****90x48**

Lavabo Cover monoforo con troppopieno
Cover one tap hole basin with overflow
Lavabo Cover para monomando con rebosadero

40349 white 40353 green
40351 black 40352 cherry
40350 yellow 40354 grey

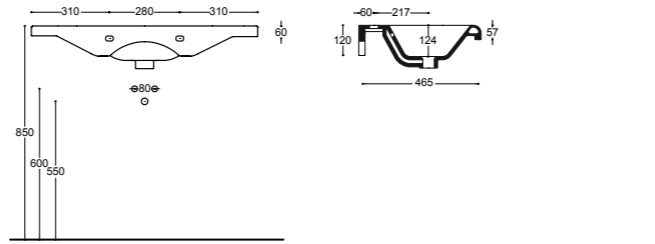
**100****100x48**

Lavabo Cover monoforo con troppopieno
Cover one tap hole basin with overflow
Lavabo Cover para monomando con rebosadero

40311 white 40332 green
40329 black 40327 cherry
40317 yellow 40335 grey

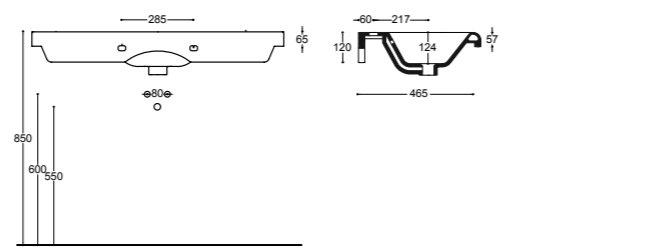
**120****120x48**

Lavabo Cover doppia vasca -2 fori con troppopieno
Cover double basin -2 tap holes with overflow
Lavabo Cover doble seno -2 agujeros con rebosadero

40337 white 40341 green
40340 black 40339 cherry
40338 yellow 40343 grey

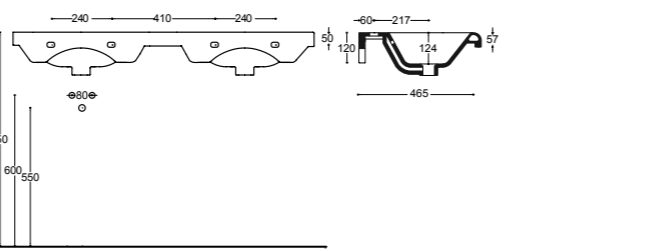
**58****58x46**

Lavabo Cover monoforo con troppopieno
Cover one tap hole basin with overflow
Lavabo Cover para monomando con rebosadero

40359 white

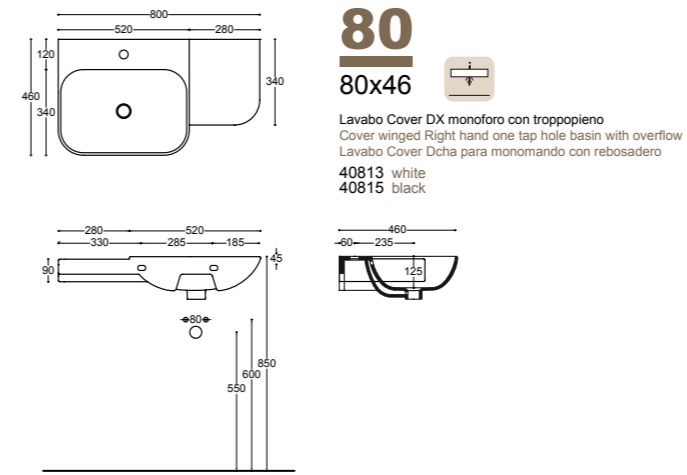
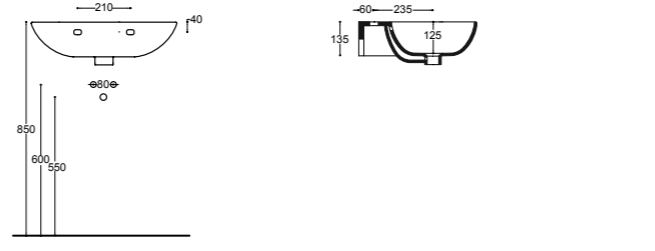
**80****80x46**

Lavabo Cover DX monoforo con troppopieno
Cover winged Right hand one tap hole basin with overflow
Lavabo Cover Dcha para monomando con rebosadero

40813 white
40815 black

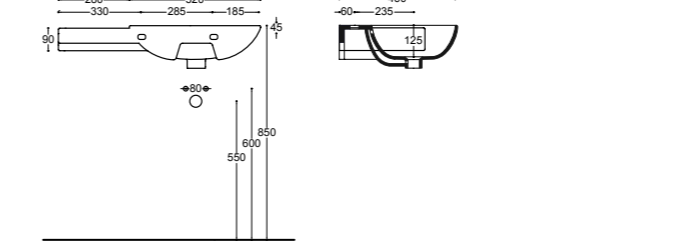
**80****80x46**

Lavabo Cover SX monoforo con troppopieno
Cover winged Left hand one tap hole basin with overflow
Lavabo Cover Izqda para monomando con rebosadero

40820 white
40822 black

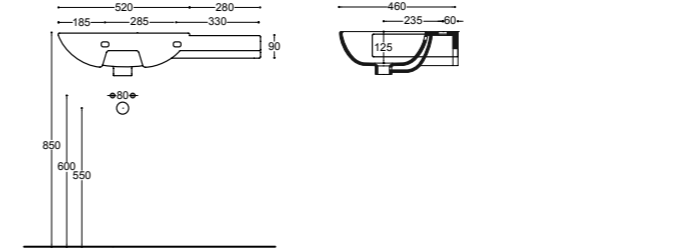
**50****50x37**

Lavabo freestanding senza troppopieno - scarico a pavimento
Freestanding basin without overflow - floor outlet
Lavabo freestanding sin rebosadero - salida vertical

40366 white
40371 black
40378 platinum

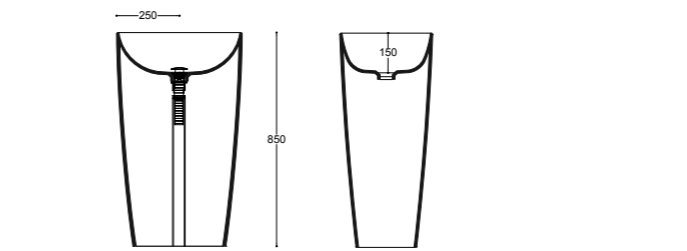
**50****50x37**

Lavabo freestanding senza troppopieno - scarico a parete
Freestanding basin without overflow - wall outlet
Lavabo freestanding sin rebosadero - salida horizontal

40381 white
40382 black
40383 platinum

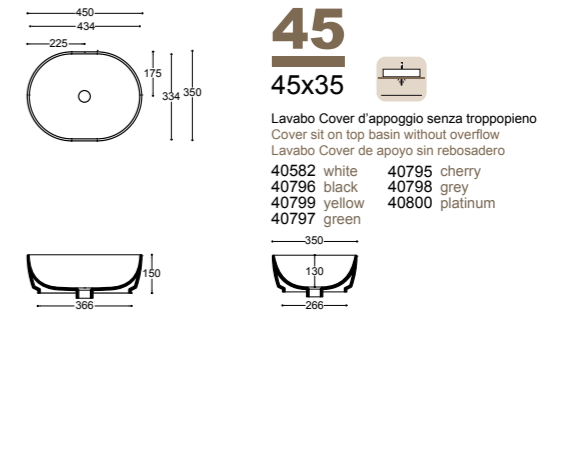
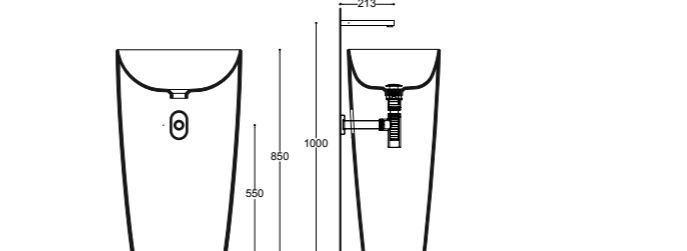
**45****45x35**

Lavabo Cover d'appoggio senza troppopieno
Cover sit on top basin without overflow
Lavabo Cover de apoyo sin rebosadero

40582 white 40795 cherry
40796 black 40798 grey
40799 yellow 40800 platinum
40797 green

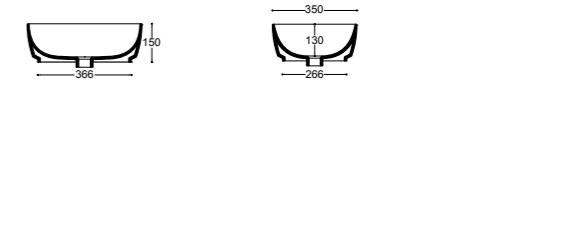
**58****58x35**

Lavabo Cover d'appoggio senza troppopieno
Cover sit on top basin without overflow
Lavabo Cover de apoyo sin rebosadero

40234 white 40242 cherry
40240 black 40241 grey
40243 yellow 40239 platinum
40245 green

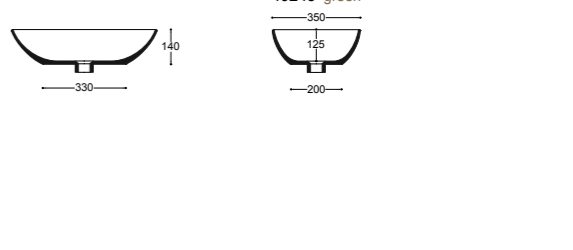
**70****70x35**

Lavabo Cover d'appoggio senza troppopieno
Cover sit on top basin without overflow
Lavabo Cover de apoyo sin rebosadero

40583 white 40801 cherry
40802 black 40804 grey
40805 yellow 40806 platinum
40803 green

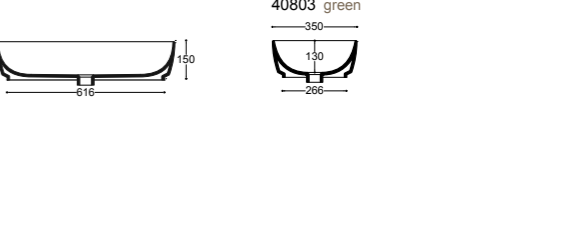
**90****90x35**

Lavabo Cover d'appoggio senza troppopieno
Cover sit on top basin without overflow
Lavabo Cover de apoyo sin rebosadero

40584 white 40807 cherry
40808 black 40810 grey
40811 yellow 40812 platinum
40809 green

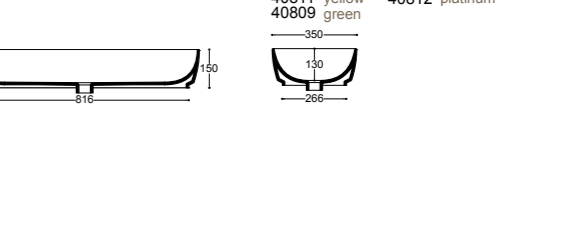

Installazione:
Installation:
Instalación:



Sospeso

Wall hung

Suspendido



Appoggio

Sit on top

Apoyo



Su colonna

With pedestal

Con pedestal



Con piedini

With legs

Con patas



Sottopiano

Under-counter

Bajo encimera



Semincasso

Semi recessed

Semiencauste



Su mobile

Cabinet basin

Con mueble

387

cover

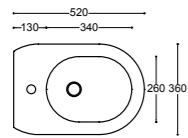
**52****52x36**

Bidet monoforo con troppopieno
One tap hole bidet with overflow
Bidé para monomando con rebosadero
40372 white
40387 black

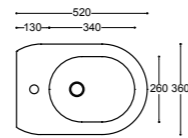
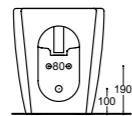
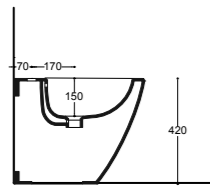
**52****52x36**

Bidet sospeso monoforo con troppopieno
Wall hung one tap hole bidet with overflow
Bidé suspendido para monomando con rebosadero
40373 white
40394 black

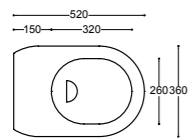
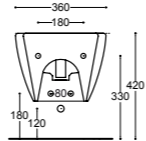
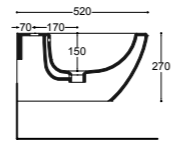
**52****52x36**

WC scarico pavimento - parete
WC floor - wall trap
Inodoro salida V/H
40374 white
40386 black

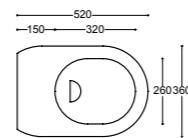
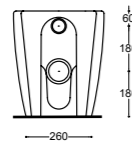
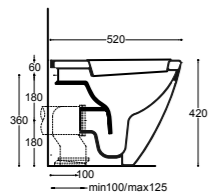
**52****52x36**

WC sospeso
Wall hung WC
Inodoro suspendido
40375 white
40393 black

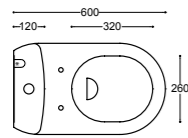
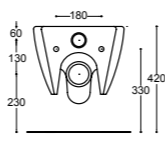
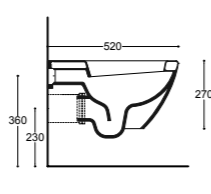
**60****60x36**

WC Monoblocco scarico pavimento parete
Close - coupled WC floor - wall trap
Inodoro para tanque bajo salida V/H
40580 white
40767 black
Cassetta monoblocco
Close - coupled cistern
Tanque bajo
40581 white
40768 black
+
Meccanismo di scarico
Mechanism for close - coupled cistern
Mecanismo de descarga
30090

* Entrata acqua
* Inlet water
* Entrada agua

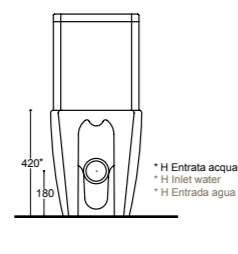
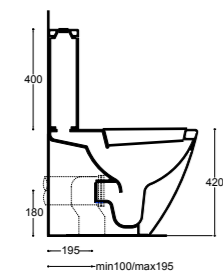

* H Entrata acqua
* H Inlet water
* H Entrada agua

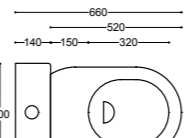
**66****66x40**

WC scarico pavimento - parete
WC floor - wall trap
Inodoro salida V/H
40374 white
40386 black
+
Totem Soft con meccanismo di scarico Geberit
Totem Soft with Geberit mechanism
Totem Soft con mecanismo de descarga Geberit
40203 white
40204 black

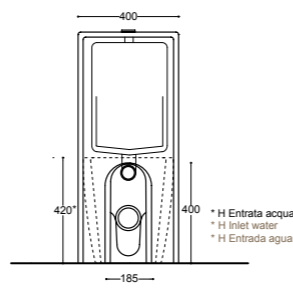
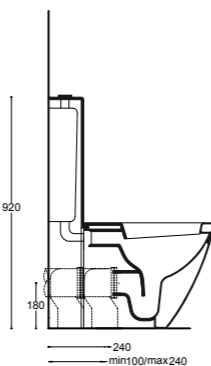

* H Entrata acqua
* H Inlet water
* H Entrada agua

Articoli supplementari**Additional items****Artículos adicionales**

Coprivaso in resina termoindurente Thermosetting resin seat cover Asiento de resina termoindurente	40376 white 40384 black
Coprivaso frizionato in resina termoindurente Thermosetting resin soft close seat cover Asiento amortiguado de resina termoindurente	40377 white 40385 black
Staffa di fissaggio per vaso e bidet sospesi Bracket for wall hung WC - bidet Estribo a "L" para inodoro - bidé suspendidos	30019
Staffa di fissaggio in plastica vaso e bidet Plastic bracket for WC - bidet Estribo en plastico para inodoro - bidé	40290
Curva tecnica Pipe fitting Codo	030070
Fissaggi per lavabo Fixings for washbasin Anclajes para lavabo	30020
Sifone Siphon Sifón	31056



Consumo d'acqua
Water flush
Consumo de agua

Installazione:
Installation:
Instalación:



Sospeso
Wall hung
Suspendido



Appoggio
Sit on top
Apoyo



Su colonna
With pedestal
Con pedestal



Con piedini
With legs
Con patas



Sottopiano
Under-counter
Bajo encimera



Semincasso
Semi recessed
Semiencastré



Su mobile
Cabinet basin
Con mueble

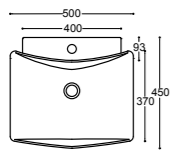

50 50x45

Lavabo Oceano monoforo con troppopieno
Oceano one tap hole basin with overflow
Lavabo Oceano para monomando con rebosadero
30328 white

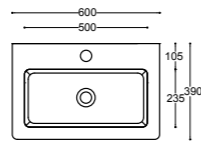
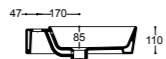
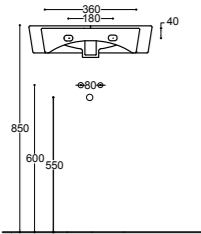

60 60x39

Lavabo Smart monoforo con troppopieno
Smart one tap hole basin with overflow
Lavabo Smart para monomando con rebosadero
40132 white
40206 black

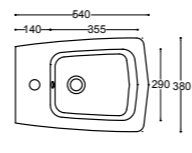
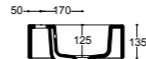
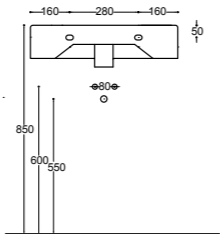

54 54x38

Bidet monoforo con troppopieno
One tap hole bidet with overflow
Bidé para monomando con rebosadero
30332 white

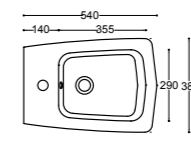
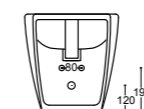
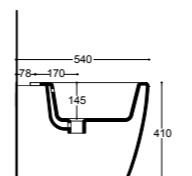

54 54x38

Bidet sospeso monoforo con troppopieno
Wall hung one tap hole bidet with overflow
Bidé suspendido para monomando con rebosadero
30334 white

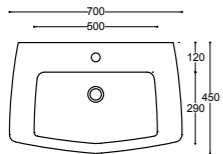
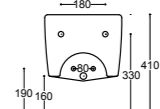
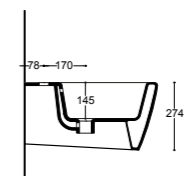

70 70x45

Lavabo Oceano monoforo con troppopieno
Oceano one tap hole basin with overflow
Lavabo Oceano para monomando con rebosadero
30329 white

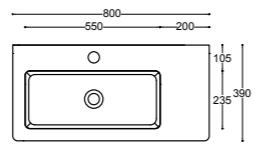
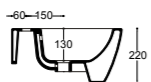
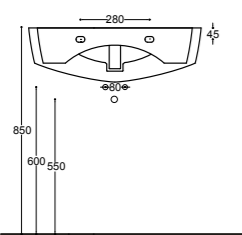

80 80x39

Lavabo Smart monoforo con troppopieno
Smart one tap hole basin with overflow
Lavabo Smart para monomando con rebosadero
40137 white
40205 black

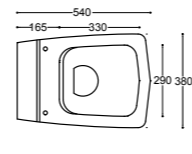
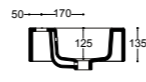
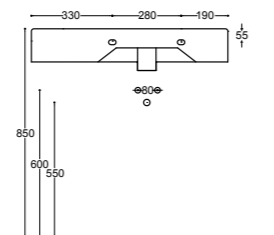

54 54x38

WC scarico pavimento - parete
WC floor - wall trap
Inodoro salida V/H
30331 white

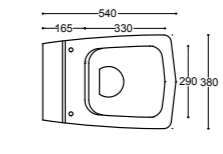
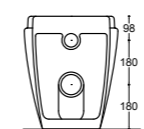
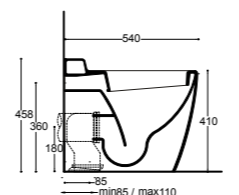

54 54x38

WC sospeso
Wall hung WC
Inodoro suspendido
30333 white

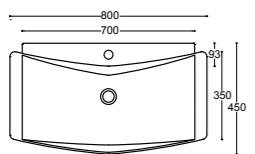
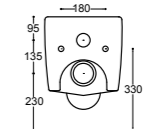
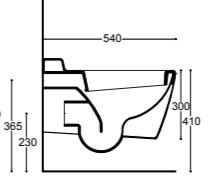

80 80x45

Lavabo Oceano monoforo con troppopieno
Oceano one tap hole basin with overflow
Lavabo Oceano para monomando con rebosadero
30330 white

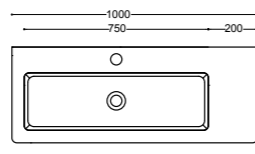
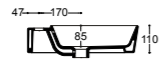
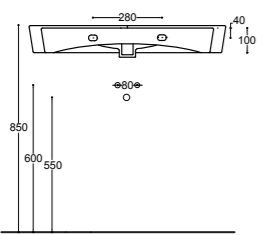

100 100x39

Lavabo Smart monoforo con troppopieno
Smart one tap hole basin with overflow
Lavabo Smart para monomando con rebosadero
40138 white
40207 black

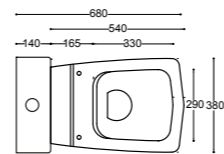
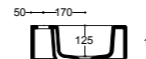
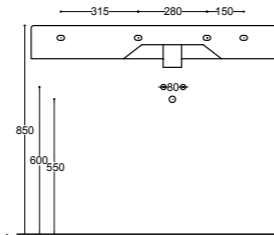

68 68x40

WC scarico pavimento - parete
WC floor - wall trap
Inodoro salida V/H
30331 white
Totem Hard con meccanismo di scarico Geberit
Totem Hard with Geberit mechanism
Totem Hard con mecanismo de descarga Geberit
40201 white
40202 black

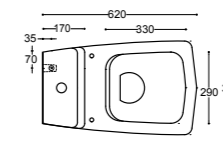
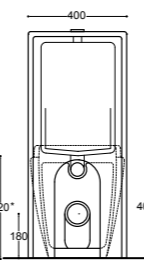
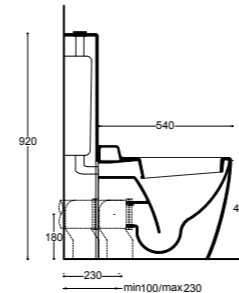

62 62x38

WC Monoblocco scarico pavimento parete
Close - coupled WC floor - wall trap
Inodoro para tanque bajo salida V/H
30424 white
Cassetta monoblocco
Close - coupled cistern
Tanque bajo
30425 white
+
Meccanismo di scarico
Mechanism for close - coupled cistern
Mecanismo de descarga
30090

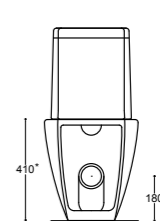
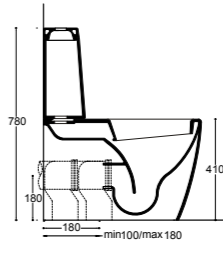

Articoli supplementari Additional items Articulos adicionales

Coprivaso in resina termoindurente Thermosetting resin seat cover Asiento de resina termoindurente	30341 white 40145 black	Curva tecnica Pipe fitting Codigo	030070
Coprivaso frizionato in resina termoindurente Thermosetting resin soft close seat cover Asiento amortiguado de resina termoindurente	40246 white 40282 black	Fissaggi per lavabo Fixings for washbasin Anclajes para lavabo	30020
Staffa di fissaggio per vaso e bidet sospesi Bracket for wall hung WC - bidet Estribo a "L" para inodoro - bidé suspendidos	30019	Sifone Siphon Sifón	31056
Staffa di fissaggio in plastica vaso e bidet Plastic bracket for WC - bidet Estribo en plastico para inodoro - bidé	40290		



Installazione:
Installation:
Instalación:

- Sospeso
Wall hung
Suspendido
- Appoggio
Sit on top
Apoyo
- Su colonna
With pedestal
Con pedestal
- Con piedini
With legs
Con patas
- Sottopiano
Under-counter
Bajo encimera
- Semincasso
Semi recessed
Semiencastré
- Su mobile
Cabinet basin
Con mueble

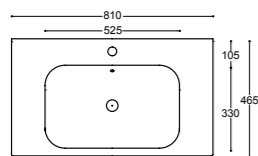

81

81x46

Lavabo Cover monoforo con troppopieno
Cover one tap hole basin with overflow
Lavabo Cover para monomando con rebosadero
40499 white

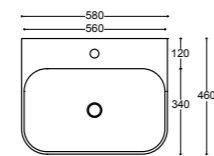
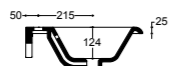
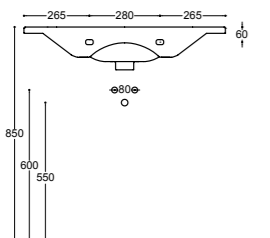

58

58x46

Lavabo Cover monoforo con troppopieno
Cover one tap hole basin with overflow
Lavabo Cover para monomando con rebosadero
40359 white

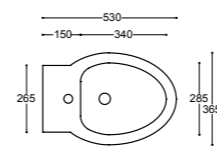
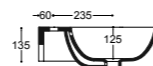
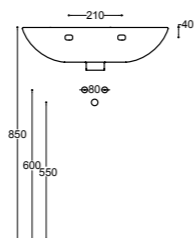

53

53x36

Bidet monoforo con troppopieno
One tap hole bidet with overflow
Bidé para monomando con rebosadero
40557 white

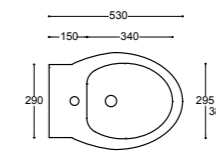
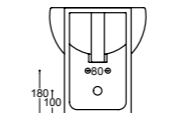
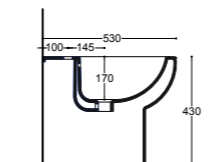

53

53x38

Bidet sospeso monoforo con troppopieno
Wall hung one tap hole bidet with overflow
Bidé suspendido para monomando con rebosadero
40558 white

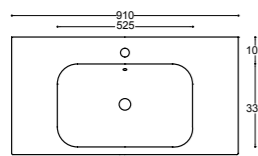
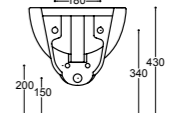
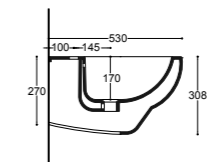

91

91x46

Lavabo Cover monoforo con troppopieno
Cover one tap hole basin with overflow
Lavabo Cover para monomando con rebosadero
40513 white

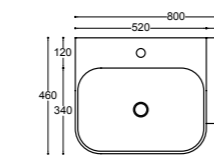
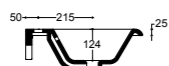
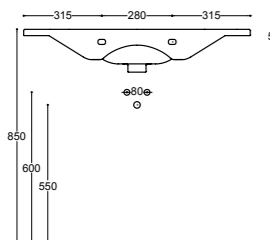

80

80x46

Lavabo Cover DX monoforo con troppopieno
Cover winged Right hand one tap hole basin with overflow
Lavabo Cover Dcha para monomando con rebosadero
40813 white
40815 black

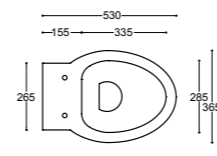
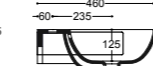
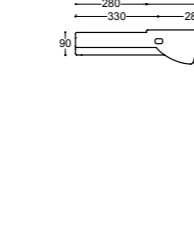

53

53x36

WC scarico pavimento - parete
WC floor - wall trap
Inodoro salida V/H
40554 white

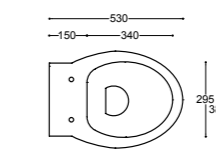
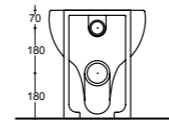
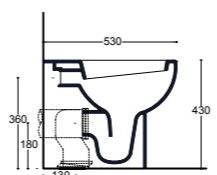

53

53x38

WC sospeso
Wall hung WC
Inodoro suspendido
40555 white

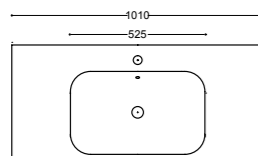
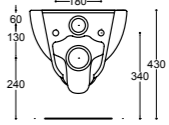
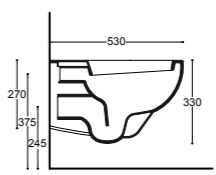

101

101x46

Lavabo Cover monoforo con troppopieno
Cover one tap hole basin with overflow
Lavabo Cover para monomando con rebosadero
40520 white

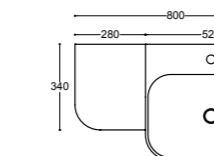
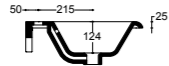
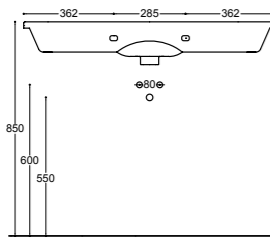

80

80x46

Lavabo Cover SX monoforo con troppopieno
Cover winged Left hand one tap hole basin with overflow
Lavabo Cover Izqda para monomando con rebosadero
40820 white
40822 black

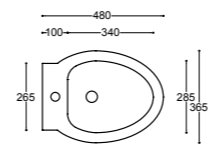
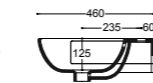
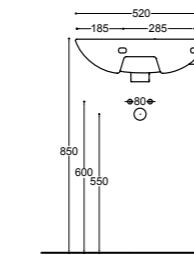

48

48x36

Bidet monoforo con troppopieno
One tap hole bidet with overflow
Bidé para monomando con rebosadero
40858 white

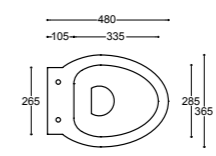
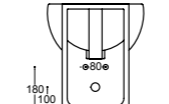
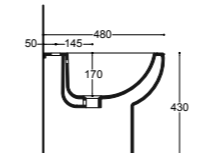

48

48x36

WC scarico pavimento - parete
WC floor - wall trap
Inodoro salida V/H
40857 white

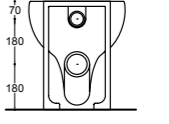
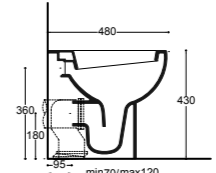

Articoli supplementari per lavabi
Additional items for basins
Artículos adicionales para lavabos

Fissaggi per lavabo Fixings for washbasin Anclajes para lavabo	30020
Sifone Siphon Sifón	31056

Articoli supplementari per sanitari
Additional items for sanitary ware
Artículos adicionales para sanitarios

Coprivaso in resina termoindurente Thermosetting resin seat cover Asiento de resina termoindurente	40560 white
Coprivaso frizionato in resina termoindurente Thermosetting resin soft close seat cover Asiento amortiguado de resina termoindurente	40561 white
Coprivaso in resina termoindurente per vaso sospeso Wall hung WC thermosetting resin seat cover Asiento de resina termoindurente para inodoro suspendido	40562 white
Coprivaso frizionato in resina termoindurente per vaso sospeso Wall hung WC thermosetting resin soft close seat cover Asiento amortiguado de resina termoindurente para inodoro suspendido	40871 white
Staffa di fissaggio per vaso e bidet sospesi Bracket for wall hung WC - bidet Estribo a "L" para inodoro - bidé suspendidos	30019
Staffa di fissaggio in plastica vaso e bidet Plastic bracket for WC - bidet Estribo en plastico para inodoro - bidé	40290
Curva tecnica Pipe fitting Codo	030070



Consumo d'acqua
Water flush
Consumo de agua

Installazione:
Installation:
Instalación:



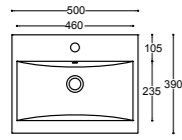

50

50x39

Lavabo Clever monoforo con troppopieno
Clever one tap hole basin with overflow
Lavabo Clever para monomando con rebosadero
30381 white

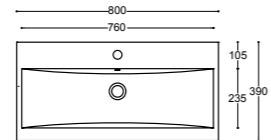
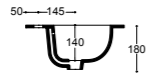
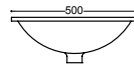

80

80x39

Lavabo Clever monoforo con troppopieno
Clever one tap hole basin with overflow
Lavabo Clever para monomando con rebosadero
30385 white

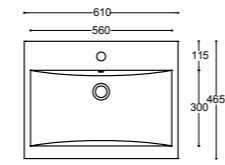
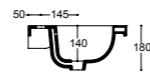
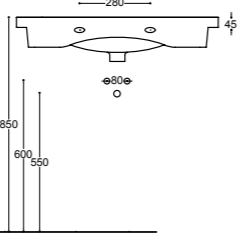

61

61x46

Lavabo Clever monoforo con troppopieno
Clever one tap hole basin with overflow
Lavabo Clever para monomando con rebosadero
40477 white

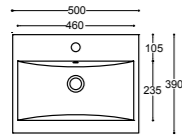
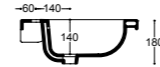
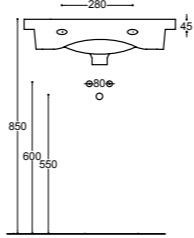

50

50x39

Lavabo Clever monoforo con troppopieno
Clever one tap hole basin with overflow
Lavabo Clever para monomando con rebosadero
30382 white

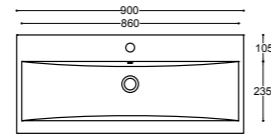
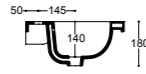
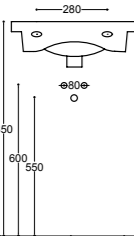

90

90x39

Lavabo Clever monoforo con troppopieno
Clever one tap hole basin with overflow
Lavabo Clever para monomando con rebosadero
30386 white

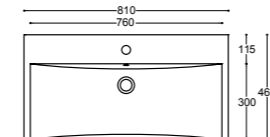
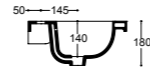
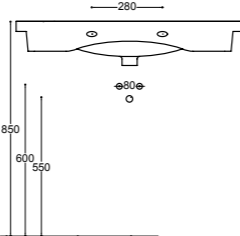

81

81x46

Lavabo Clever monoforo con troppopieno
Clever one tap hole basin with overflow
Lavabo Clever para monomando con rebosadero
40479 white

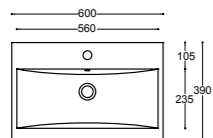
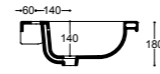
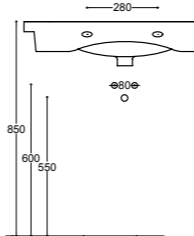

60

60x39

Lavabo Clever monoforo con troppopieno
Clever one tap hole basin with overflow
Lavabo Clever para monomando con rebosadero
30383 white

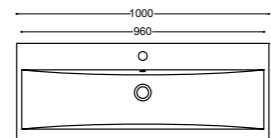
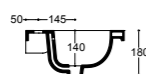
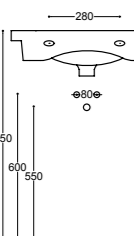

100

100x39

Lavabo Clever monoforo con troppopieno
Clever one tap hole basin with overflow
Lavabo Clever para monomando con rebosadero
30387 white

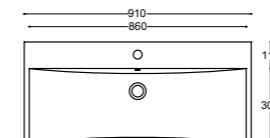
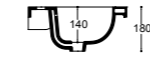
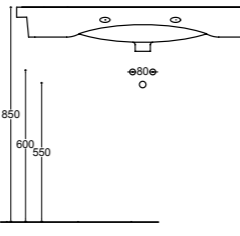

91

91x46

Lavabo Clever monoforo con troppopieno
Clever one tap hole basin with overflow
Lavabo Clever para monomando con rebosadero
40480 white

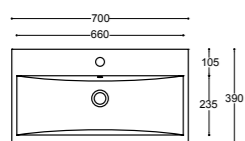
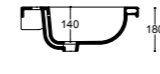
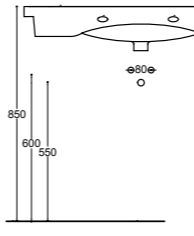

70

70x39

Lavabo Clever monoforo con troppopieno
Clever one tap hole basin with overflow
Lavabo Clever para monomando con rebosadero
30384 white

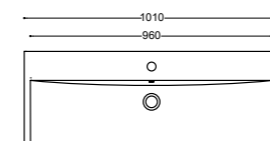
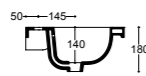
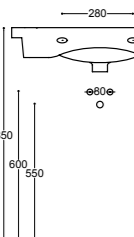

101

101x46

Lavabo Clever monoforo con troppopieno
Clever one tap hole basin with overflow
Lavabo Clever para monomando con rebosadero
40481 white

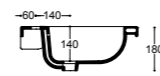
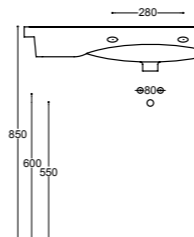

Installazione:
Installation:
Instalación:



Sospeso
Wall hung
Suspendido



Appoggio
Sit on top
Apoyo



Su colonna
With pedestal
Con pedestal



Con piedini
With legs
Con patas



Sottopiano
Under-counter
Bajo encimera



Semincasso
Semi recessed
Semiencastré



Su mobile
Cabinet basin
Con mueble

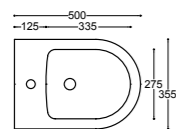

50
50x35

Bidet monoforo con troppopieno
One tap hole bidet with overflow
Bidé para monomando con rebosadero
40567 white

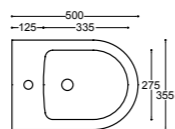
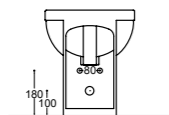
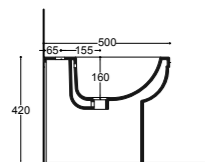

50
50x35

Bidet sospeso monoforo con troppopieno
Wall hung one tap hole bidet with overflow
Bidé suspendido para monomando con rebosadero
40569 white

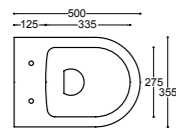
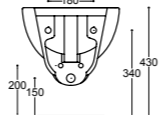
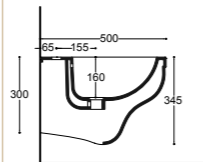

50
50x35

WC scarico pavimento - parete
WC floor - wall trap
Inodoro salida V/H
40566 white

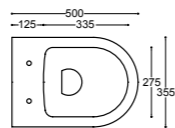
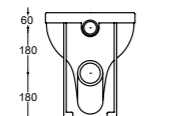
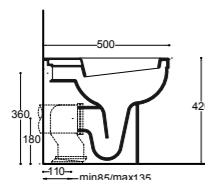

50
50x35

WC sospeso
Wall hung WC
Inodoro suspendido
40568 white

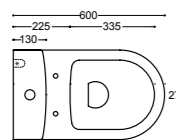
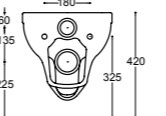
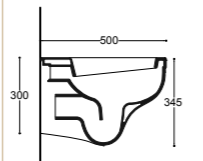

60
60x35

WC monoblocco scarico pavimento parete
Close - coupled WC floor - wall trap
Inodoro para tanque bajo salida V/H

* Entrata acqua
* Inlet water
* Entrada agua

40570 white
Cassetta monoblocco
Close - coupled cistern
Tanque bajo

40571 white

+
Meccanismo di scarico
Mechanism for close - coupled cistern
Mecanismo de descarga
30090

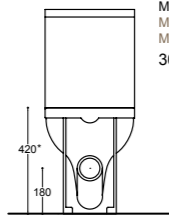
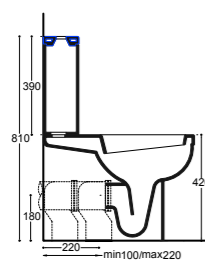

* H Entrata acqua
* H Inlet water
* H Entrada agua

Articoli supplementari Additional items Artículos adicionales

Coprivaso in resina termoindurente Thermosetting resin seat cover Asiento de resina termoindurente	40572 white
Coprivaso frizionato in resina termoindurente Thermosetting resin soft close seat cover Asiento amortiguado de resina termoindurente	40573 white
Staffa di fissaggio per vaso e bidet sospesi Bracket for wall hung WC - bidet Estribo a "L" para inodoro - bidé suspendidos	30019
Staffa di fissaggio in plastica vaso e bidet Plastic bracket for WC - bidet Estribo en plástico para inodoro - bidé	40290
Curva tecnica Pipe fitting Codo	030070
Fissaggi per lavabo Fixings for washbasin Anclajes para lavabo	30020



Consumo d'acqua
Water flush
Consumo de agua

Installazione:
Installation:
Instalación:



Sospeso
Wall hung
Suspendido



Appoggio
Sit on top
Apoyo



Su colonna
With pedestal
Con pedestal



Con piedini
With legs
Con patas



Sottopiano
Under-counter
Bajo encimera



Semincasso
Semi recessed
Semiencastré



Su mobile
Cabinet basin
Con mueble

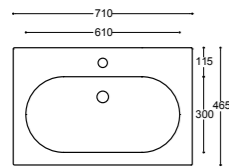

71

71x46



Lavabo Pink monoforo con troppopieno
"Pink" one tap hole basin with overflow
Lavabo Pink para monomando con rebosadero
40546 white

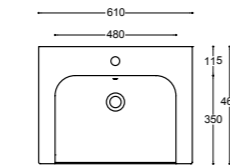
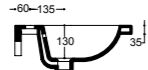
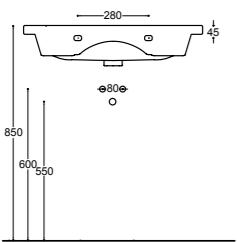

61

61x46



Lavabo Stilo monoforo con troppopieno
Stilo one tap hole basin with overflow
Lavabo Stilo para monomando con rebosadero
40482 white

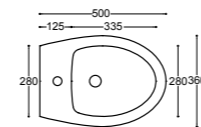
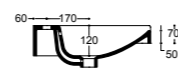
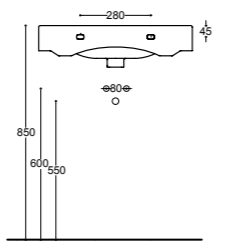

50

50x36

Bidet monoforo con troppopieno
One tap hole bidet with overflow
Bidé para monomando con rebosadero
40575 white

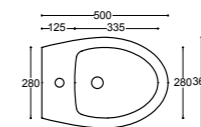
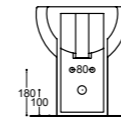
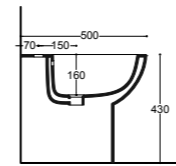

50

50x36

Bidet sospeso monoforo con troppopieno
Wall hung one tap hole bidet with overflow
Bidé suspendido para monomando con rebosadero
40577 white

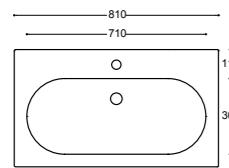
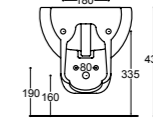
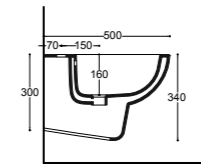

81

81x46



Lavabo Pink monoforo con troppopieno
"Pink" one tap hole basin with overflow
Lavabo Pink para monomando con rebosadero
40547 white

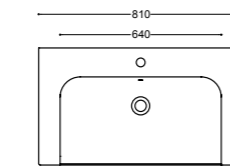
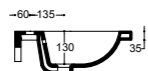
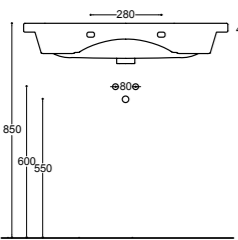

81

81x46



Lavabo Stilo monoforo con troppopieno
Stilo one tap hole basin with overflow
Lavabo Stilo para monomando con rebosadero
40483 white

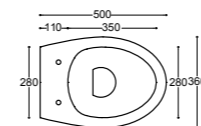
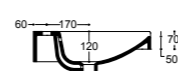
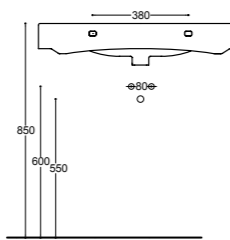

50

50x36



WC scarico pavimento - parete
WC floor - wall trap
Inodoro salida V/H
40574 white

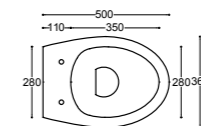
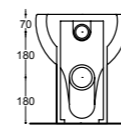
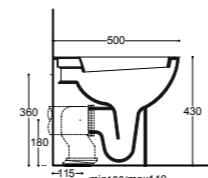

50

50x36



WC sospeso
Wall hung WC
Inodoro suspendido
40576 white

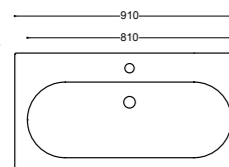
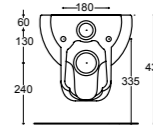
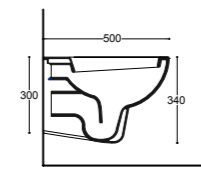

91

91x46



Lavabo Pink monoforo con troppopieno
"Pink" one tap hole basin with overflow
Lavabo Pink para monomando con rebosadero
40548 white

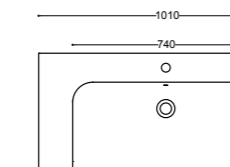
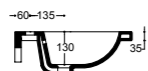
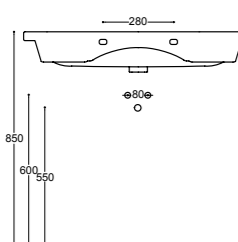

101

101x46



Lavabo Stilo monoforo con troppopieno
Stilo one tap hole basin with overflow
Lavabo Stilo para monomando con rebosadero
40484 white

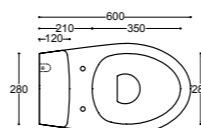
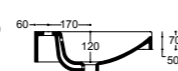
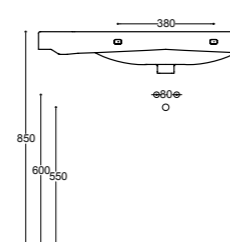

60

60x36



WC Monoblocco scarico pavimento parete
Close - coupled WC floor - wall trap
Inodoro para tanque bajo salida V/H

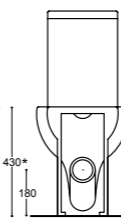
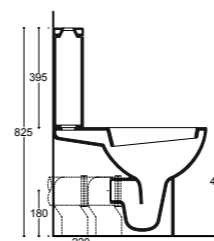

40578 white
Cassetta monoblocco
Close - coupled cistern
Tanque bajo
40579 white
+
Meccanismo di scarico
Mechanism for close - coupled cistern
Mecanismo de descarga
30090

* H Entrata acqua
* H Inlet water
* H Entrada agua

Articoli supplementari
Additional items
Artículos adicionales

Coprivaso in resina termoindurente Thermosetting resin seat cover Asiento de resina termoindurente	40849 white
Coprivaso frizionato in resina termoindurente Thermosetting resin soft close seat cover Asiento amortiguado de resina termoindurente	40850 white
Staffa di fissaggio per vaso e bidet sospesi Bracket for wall hung WC - bidet Estribo a "L" para inodoro - bidé suspendidos	30019
Staffa di fissaggio in plastica vaso e bidet Plastic bracket for WC - bidet Estribo en plastica para inodoro - bidé	40290
Curva tecnica Pipe fitting Codo	030070
Fissaggi per lavabo Fixings for washbasin Anclajes para lavabo	30020
Sifone Siphon Sifón	31056



Consumo d'acqua
Water flush
Consumo de agua

Installazione:
Installation:
Instalación:

- Sospeso
Wall hung
Suspendido
- Appoggio
St on top
Apoyo
- Su colonna
With pedestal
Con pedestal
- Con piedini
With legs
Con patas
- Sottopiano
Under-counter
Bajo encimera
- Semincasso
Semi recessed
Semiencastré
- Su mobile
Cabinet basin
Con mueble

70 KG 25
70x45x53

Mobile sospeso a 2 cassetti e maniglie cromate
Wall hung cabinet with 2 drawers and chromed handles
Mueble suspendido con 2 cajones y tiradores cromados

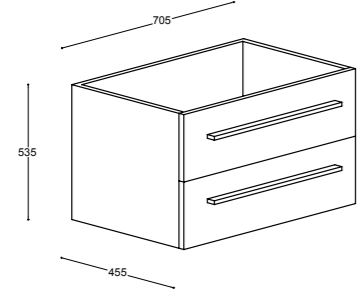

80 KG 28
80x45x53

Mobile sospeso a 2 cassetti e maniglie cromate
Wall hung cabinet with 2 drawers and chromed handles
Mueble suspendido con 2 cajones y tiradores cromados

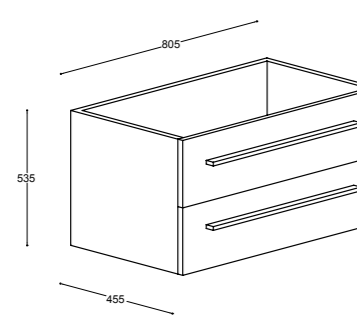
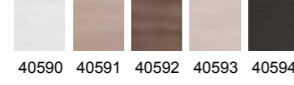

100 KG 31
100x45x53

Mobile sospeso a 2 cassetti e maniglie cromate
Wall hung cabinet with 2 drawers and chromed handles
Mueble suspendido con 2 cajones y tiradores cromados

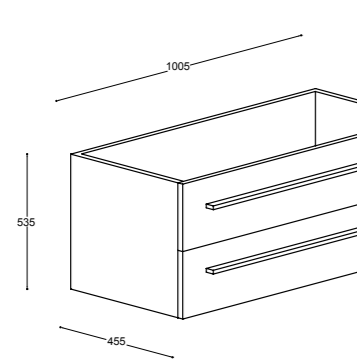
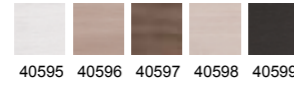

60 KG 16
60x45x53

Mobile sospeso a 2 ante con apertura push system
Wall hung cabinet with 2 push system doors
Mueble suspendido con 2 puertas y push system

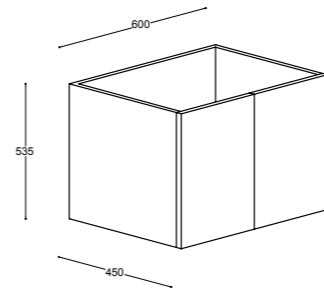
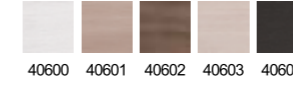

70 KG 17
70x45x53

Mobile sospeso a 2 ante con apertura push system
Wall hung cabinet with 2 push system doors
Mueble suspendido con 2 puertas y push system

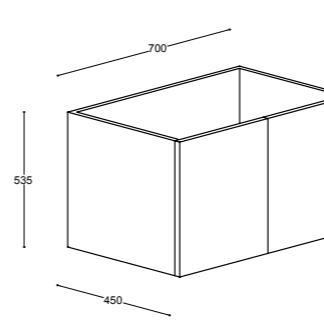

80 KG 18
80x45x53

Mobile sospeso a 2 ante con apertura push system
Wall hung cabinet with 2 push system doors
Mueble suspendido con 2 puertas y push system

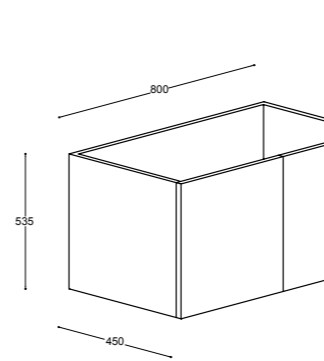
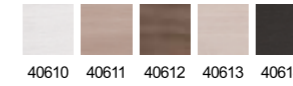

90 KG 25
90x45x53

Mobile sospeso a 3 ante con apertura push system
Wall hung cabinet with 3 push system doors
Mueble suspendido con 3 puertas y push system

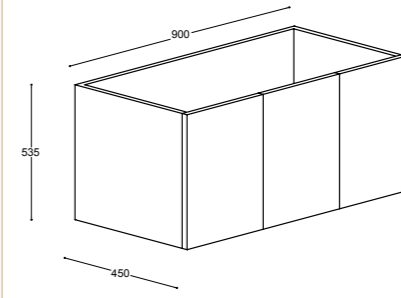
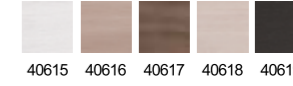

100 KG 27
100x45x53

Mobile sospeso a 3 ante con apertura push system
Wall hung cabinet with 3 push system doors
Mueble suspendido con 3 puertas y push system

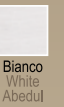
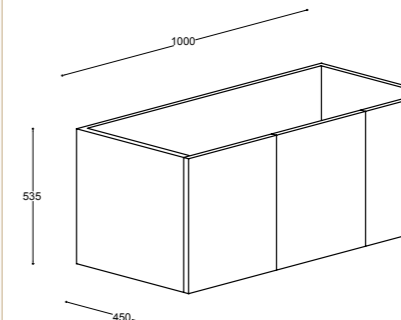

Bianco
White
Abedul

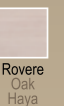

Rovere
Oak
Haya

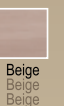

Beige
Beige
Beige

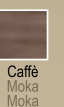

Caffè
Moka
Moka



Wenge
Wenge
Wenge

H.124

35x33x124

Semicolonna con maniglia a 3 cassetti e 1 anta dx - sx
Wall hung high cabinet with handles, 3 drawers and 1 door opening left or right
Semicolumna con tirador con 3 cajones y 1 puerta dcha-izqda



40635 40636 40637 40638 40639 DX
40640 40641 40642 40643 40644 SX

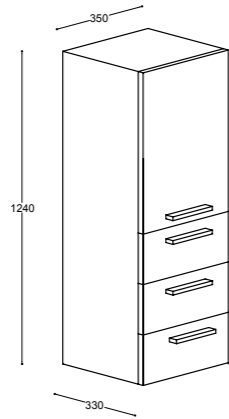

DX 40645 40646 40647 40648 40649
SX 40650 40651 40652 40653 40654

Semicolonna senza maniglia a 3 cassetti e 1 anta dx - sx
Wall hung high cabinet with push system, 3 drawers and 1 door opening left or right
Semicolumna sin tirador con 3 cajones y 1 puerta dcha-izqda

H.174

35x33x174

Colonna con maniglia con 1 anta reversibile
Wall hung high cabinet with handle and 1 reversible door
Columna con tirador y 1 puerta reversible

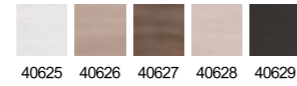

40625 40626 40627 40628 40629

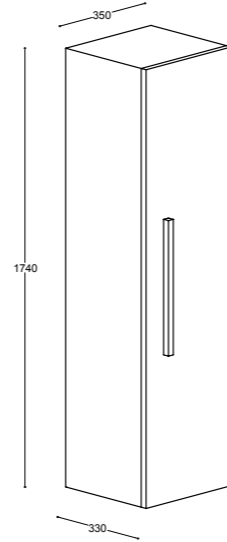

40630 40631 40632 40633 40634

Colonna senza maniglia con 1 anta reversibile
Wall hung high cabinet with push system and 1 reversible door
Columna sin tirador con 1 puerta reversible

35

35x41x59

Base con ruote con maniglia, anta DX
Floor cabinet on castors with handle, 1 door opening right
Base con ruedas con tirador y 1 puerta dcha

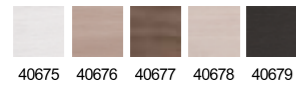

40675 40676 40677 40678 40679

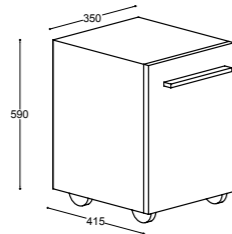

57

57x27x58

Pensile con maniglia, 1 anta dx - sx
Wall cabinet with 1 handle, 1 door opening left or right
Camerino con tirador y 1 puerta dcha-izqda

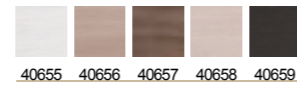

40655 40656 40657 40658 40659 DX
40660 40661 40662 40663 40664 SX

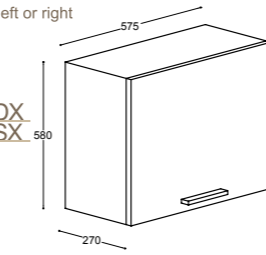

Pensile con apertura push system, 1 anta dx - sx
Wall cabinet with push system, 1 door opening left or right
Camerino con 1 puerta push system dcha-izqda



DX 40665 40666 40667 40668 40669
SX 40670 40671 40672 40673 40674

80 - 90 - 100

80x15x74 - 90x15x74 - 100x15x74

Specchio e pensile con maniglia dx o sx
Mirror plus left or right wall cabinet with handle
Espejo y camerino con tirador dcha - izqda



40705 40706 40707 40708 40709 L.80 DX
40725 40726 40727 40728 40729 L.90 DX
40745 40746 40747 40748 40749 L.100 DX

40710 40711 40712 40713 40714 L.80 SX
40730 40731 40732 40733 40734 L.90 SX
40750 40751 40752 40753 40754 L.100 SX

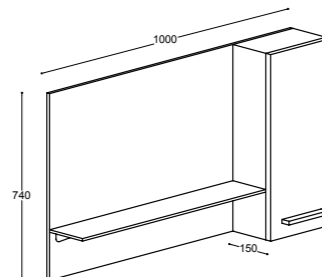
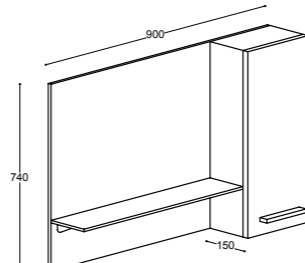
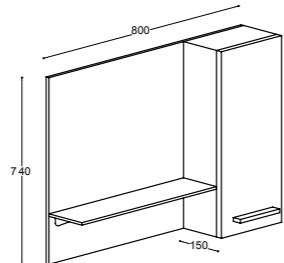

Specchio e pensile con apertura push system dx o sx
Mirror plus left or right wall cabinet with push system
Espejo y camerino con 1 puerta push system dcha - izqda



L.80 DX 40715 40716 40717 40718 40719
L.90 DX 40735 40736 40737 40738 40739
L.100 DX 40755 40756 40757 40758 40759
L.80 SX 40720 40721 40722 40723 40724
L.90 SX 40740 40741 40742 40743 40744
L.100 SX 40760 40761 40762 40763 40764

60

60x80

Specchio a filo lucido
Glossy flush mirror
Espejo

40695

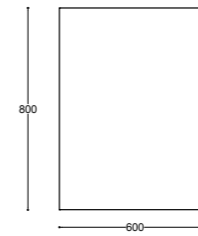

70

70x80

Specchio a filo lucido
Glossy flush mirror
Espejo

40696

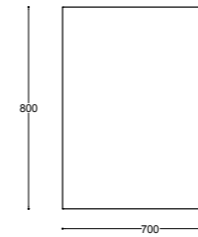

80

80x80

Specchio a filo lucido
Glossy flush mirror
Espejo

40697



90

90x80

Specchio a filo lucido
Glossy flush mirror
Espejo

40698

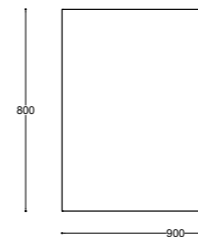

100

100x80

Specchio a filo lucido
Glossy flush mirror
Espejo

40699

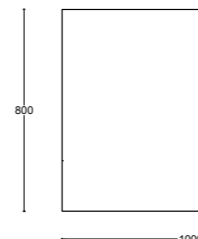

Appliche Cubo
Cube spotlight
Apliche Cubo

40765

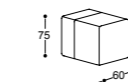

70

70x80

Specchio con 1 luce interna LED orizzontale
Mirror complete with 1 internal horizontal LED light
Espejo con 1 luz interna LED horizontal

40700

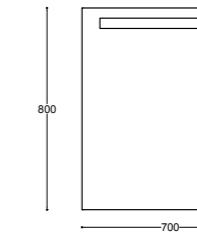

80

80x80

Specchio con 1 luce interna LED orizzontale
Mirror complete with 1 internal horizontal LED light
Espejo con 1 luz interna LED horizontal

40701

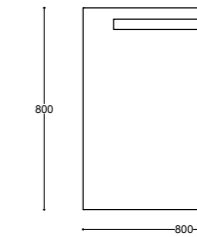

90

90x80

Specchio con 1 luce interna LED orizzontale
Mirror complete with 1 internal horizontal LED light
Espejo con 1 luz interna LED horizontal

40702

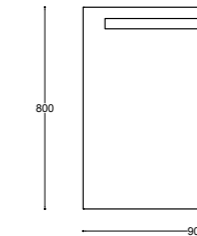

100

100x80

Specchio con 1 luce interna LED orizzontale
Mirror complete with 1 internal horizontal LED light
Espejo con 1 luz interna LED horizontal

40703

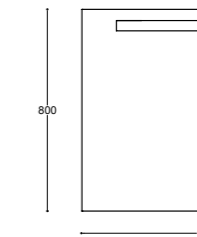

Gamba cromata H 30 per basi e colonne sospese
Chromed leg H 30 for wall hung cabinets and wall hung high cabinets
Pata cromada H 30 para bases y columnas suspendidas

40704

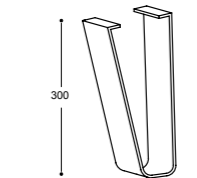

Appliche Cilindro
Cylinder spotlight
Apliche Cilindro

40766



110
110x75 ^{KG}₃₂
 Piatto doccia Outline H 8,5 cm
 Outline shower tray H 8,5 cm
 Plato de ducha Outline H 8,5 cm

40171 white
 40172 black
 40174 yellow
 40175 green
 40173 cherry

100
100x100 ^{KG}₃₈
 Piatto doccia H 5,5 cm
 Shower tray H 5,5 cm
 Plato de ducha H 5,5 cm

P2065D01A white
 P2065D04A black
 P2065D11A yellow
 P2065D07A grey
 P2065D02A cherry

170
170x70 ^{KG}₄₈
 Piatto doccia H 5,5 cm
 Shower tray H 5,5 cm
 Plato de ducha H 5,5 cm

40842 white
 40844 black
 40846 yellow
 40845 grey
 40843 cherry

90
90x90 ^{KG}₃₃
 Piatto doccia H 5,5 cm
 Shower tray H 5,5 cm
 Plato de ducha H 5,5 cm

40250 white
 40260 black
 40261 yellow
 40262 grey
 40263 cherry

90
90x90 ^{KG}₂₉
 Piatto doccia H 5,5 cm
 Shower tray H 5,5 cm
 Plato de ducha H 5,5 cm

40402 white
 40475 black
 40474 yellow
 40473 grey
 40472 cherry

160
160x70 ^{KG}₄₃
 Piatto doccia H 5,5 cm
 Shower tray H 5,5 cm
 Plato de ducha H 5,5 cm

40837 white
 40839 black
 40841 yellow
 40840 grey
 40838 cherry

80
80x80 ^{KG}₂₆
 Piatto doccia H 5,5 cm
 Shower tray H 5,5 cm
 Plato de ducha H 5,5 cm

40249 white
 40256 black
 40257 yellow
 40258 grey
 40259 cherry

80
80x80 ^{KG}₂₃
 Piatto doccia H 5,5 cm
 Shower tray H 5,5 cm
 Plato de ducha H 5,5 cm

40251 white
 40264 black
 40265 yellow
 40266 grey
 40267 cherry

140
140x80 ^{KG}₄₃
 Piatto doccia H 5,5 cm
 Shower tray H 5,5 cm
 Plato de ducha H 5,5 cm

40401 white
 40471 black
 40470 yellow
 40469 grey
 40468 cherry

140
140x70 ^{KG}₃₈
 Piatto doccia H 5,5 cm
 Shower tray H 5,5 cm
 Plato de ducha H 5,5 cm

40328 white
 40333 black
 40330 yellow
 40334 grey
 40331 cherry

Installazione:
 Installation:
 Instalación:



Lato non smaltato
 Unglazed side
 Lado no esmaltado



Filo pavimento
 Low profile shower tray
 Ras de pavimento





Appoggio su pavimento
 Standard shower tray
 De apoyo al pavimento

120
120x80  KG 39

Piatto doccia H 5,5 cm
Shower tray H 5,5 cm
Plato de ducha H 5,5 cm

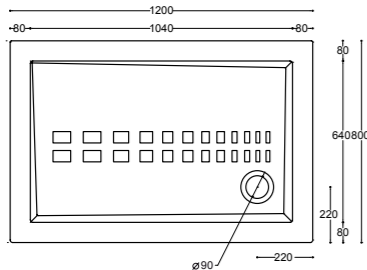
- 40400 white
- 40434 black
- 40467 yellow
- 40466 grey
- 40465 cherry





100
100x80  KG 32

Piatto doccia H 5,5 cm
Shower tray H 5,5 cm
Plato de ducha H 5,5 cm

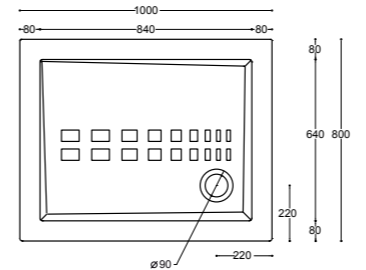
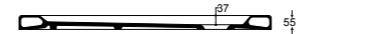

- 40399 white
- 40464 black
- 40463 yellow
- 40462 grey
- 40461 cherry



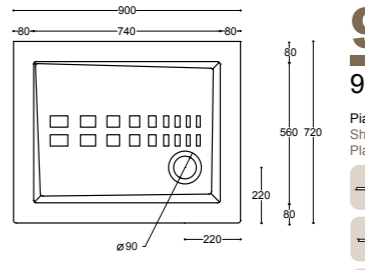

90
90x72  KG 26

Piatto doccia H 5,5 cm
Shower tray H 5,5 cm
Plato de ducha H 5,5 cm



- 40248 white
- 40252 black
- 40253 yellow
- 40254 grey
- 40255 cherry



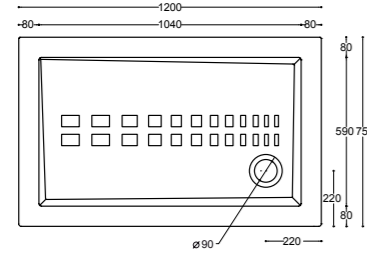

120
120x75  KG 38

Piatto doccia H 5,5 cm
Shower tray H 5,5 cm
Plato de ducha H 5,5 cm



- P2065201A white
- P2065204A black
- P2065211A yellow
- P2065207A grey
- P2065202A cherry



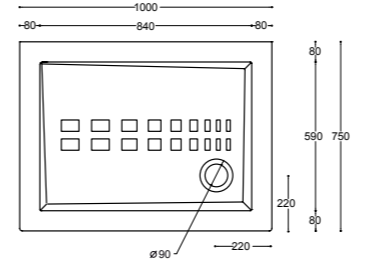

100
100x75  KG 33

Piatto doccia H 5,5 cm
Shower tray H 5,5 cm
Plato de ducha H 5,5 cm

- P2065101A white
- P2065104A black
- P2065111A yellow
- P2065107A grey
- P2065102A cherry





90
90x72  KG 28

Piatto doccia - DX H 5,5 cm
Shower tray - Right H 5,5 cm
Plato de ducha - Dcha H 5,5 cm

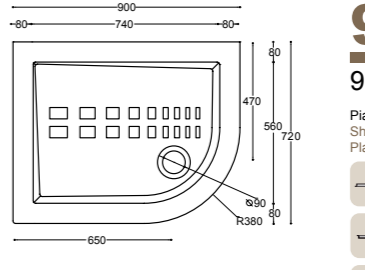
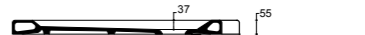

- 40827 white
- 40829 black
- 40831 yellow
- 40830 grey
- 40828 cherry



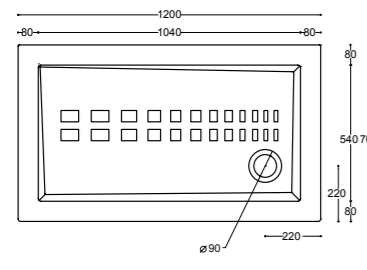

120
120x70  KG 34

Piatto doccia H 5,5 cm
Shower tray H 5,5 cm
Plato de ducha H 5,5 cm



- 40398 white
- 40460 black
- 40459 yellow
- 40458 grey
- 40457 cherry



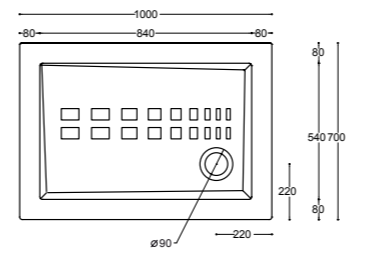

100
100x70  KG 29

Piatto doccia H 5,5 cm
Shower tray H 5,5 cm
Plato de ducha H 5,5 cm



- 40397 white
- 40456 black
- 40455 yellow
- 40454 grey
- 40453 cherry

90
90x72  KG 28

Piatto doccia - SX H 5,5 cm
Shower tray - Left H 5,5 cm
Plato de ducha - Izqda H 5,5 cm

- 40832 white
- 40834 black
- 40836 yellow
- 40835 grey
- 40833 cherry

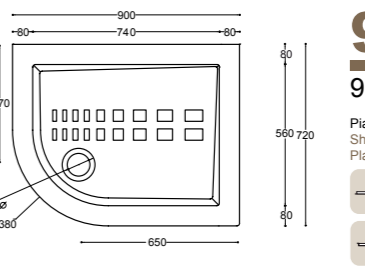
Installazione:
Installation:
Instalación:



Lato non smaltato
Unglazed side
Lado no esmaltado



Filo pavimento
Low profile shower tray
Ras de pavimento



Appoggio su pavimento
Standard shower tray
De apoyo al pavimento

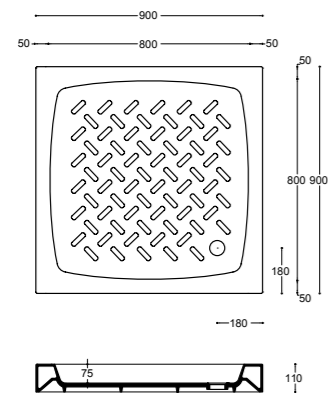

90
90x90 ^{KG} 39
Piatto doccia H 11 cm
Shower tray H 11 cm
Plato de ducha H 11 cm
31078 white

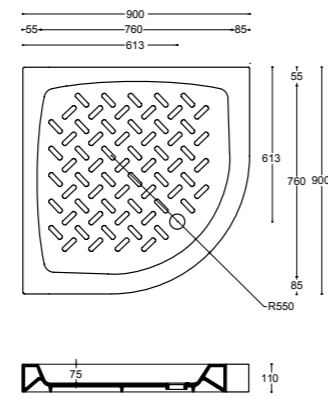

90
90x90 ^{KG} 36
Piatto doccia H 11 cm
Shower tray H 11 cm
Plato de ducha H 11 cm
31081 white

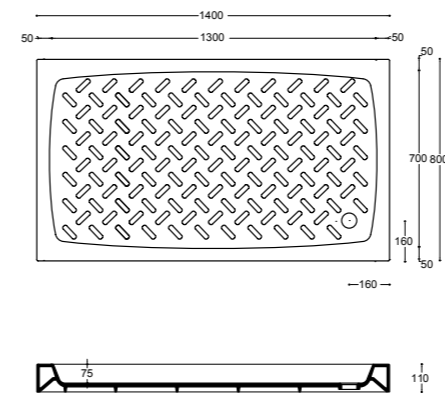

140
140x80 ^{KG} 54
Piatto doccia H 11 cm
Shower tray H 11 cm
Plato de ducha H 11 cm
40396 white

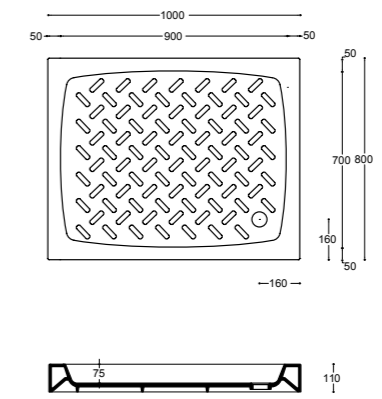

100
100x80 ^{KG} 41
Piatto doccia H 11 cm
Shower tray H 11 cm
Plato de ducha H 11 cm
30342 white

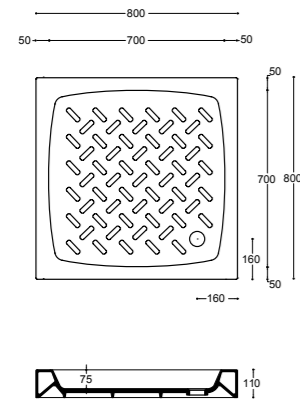

80
80x80 ^{KG} 33
Piatto doccia H 11 cm
Shower tray H 11 cm
Plato de ducha H 11 cm
31077 white

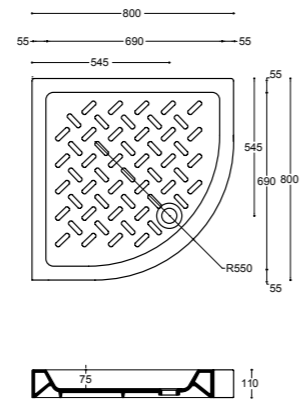

80
80x80 ^{KG} 29
Piatto doccia H 11 cm
Shower tray H 11 cm
Plato de ducha H 11 cm
31080 white

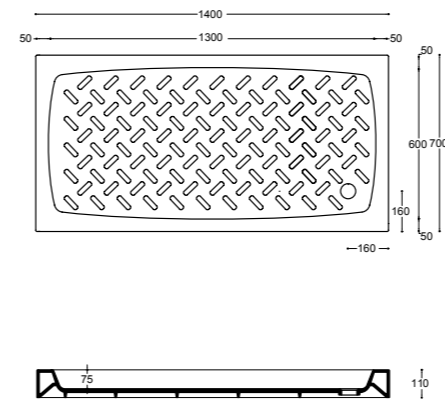

140
140x70 ^{KG} 47
Piatto doccia H 11 cm
Shower tray H 11 cm
Plato de ducha H 11 cm
40395 white

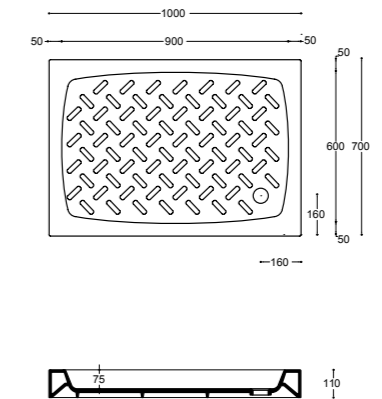

100
100x70 ^{KG} 39
Piatto doccia H 11 cm
Shower tray H 11 cm
Plato de ducha H 11 cm
31085 white

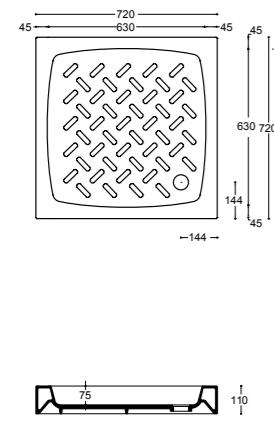

72
72x72 ^{KG} 27
Piatto doccia H 11 cm
Shower tray H 11 cm
Plato de ducha H 11 cm
31076 white

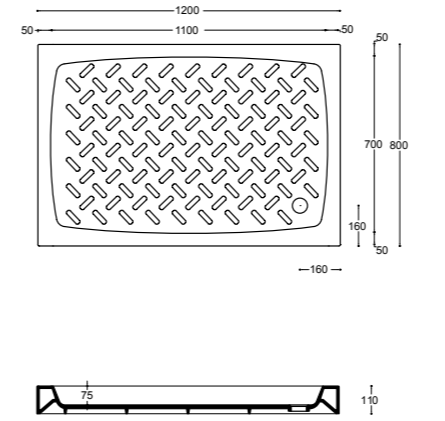

120
120x80 ^{KG} 46
Piatto doccia H 11 cm
Shower tray H 11 cm
Plato de ducha H 11 cm
31087 white

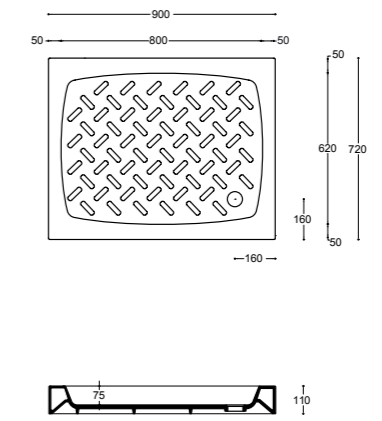

90
90x72 ^{KG} 33
Piatto doccia H 11 cm
Shower tray H 11 cm
Plato de ducha H 11 cm
31084 white

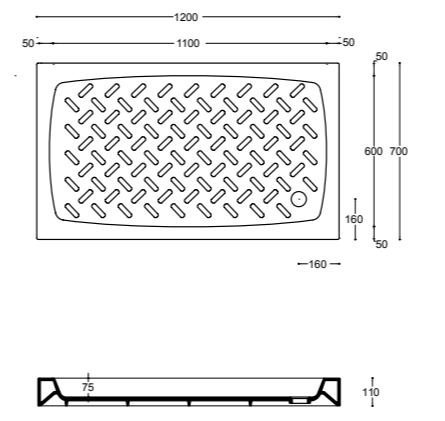

120
120x70 ^{KG} 42
Piatto doccia H 11 cm
Shower tray H 11 cm
Plato de ducha H 11 cm
31086 white

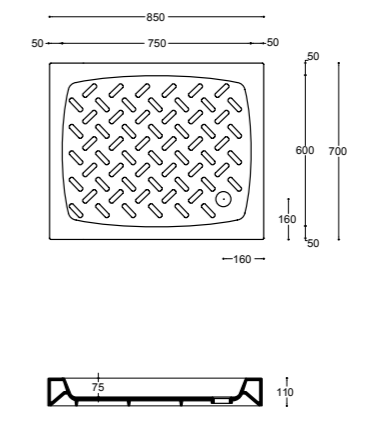

85
85x70 ^{KG} 31
Piatto doccia H 11 cm
Shower tray H 11 cm
Plato de ducha H 11 cm
31083 white



Installazione:
Installation:
Instalación:



* Lato non smaltato
Un glazed side
Lado no esmaltado



Appoggio su pavimento
Standard shower tray
De apoyo al pavimento

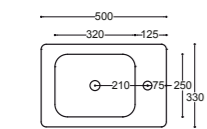

50

50X33

Lavabo Outline monoforo senza troppopieno
Outline one tap hole basin without overflow
Lavabo Outline para monomando sin rebosadero

- | | |
|--------------------|--------------------|
| 30352 white | 30486 white/yellow |
| 30484 black | 30488 white/green |
| 30487 white/cherry | 40104 black/bijoux |
| 30489 white/black | 40103 white/bijoux |

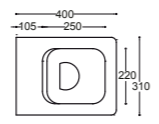
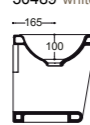
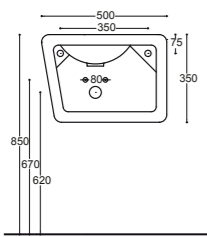

40

40X31

WC baby
WC baby
Inodoro baby

- | |
|--------------------|
| 30348 white |
| 30460 black |
| 30462 white/cherry |
| 30464 white/black |
| 30461 white/yellow |
| 30463 white/green |

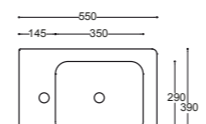
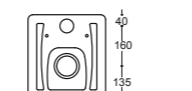
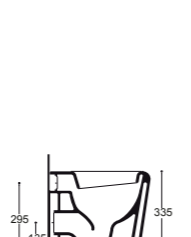

55

55X39

Bidet monoforo senza troppopieno
One tap hole bidet without overflow
Bidé para monomando sin rebosadero

- | |
|--------------------|
| 30344 white |
| 30419 black |
| 30446 white/cherry |
| 30448 white/black |
| 30445 white/yellow |
| 30447 white/green |
| 40118 black/bijoux |
| 40117 white/bijoux |

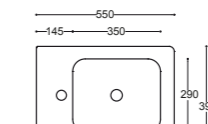
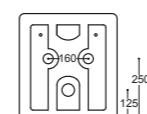
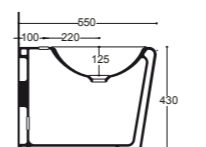

55

55X39

Bidet sospeso monoforo senza troppopieno
Wall hung one tap hole bidet without overflow
Bidé suspendido para monomando sin rebosadero

- | |
|--------------------|
| 30346 white |
| 30432 black |
| 30456 white/cherry |
| 30458 white/black |
| 30455 white/yellow |
| 30457 white/green |
| 40124 black/bijoux |
| 40123 white/bijoux |

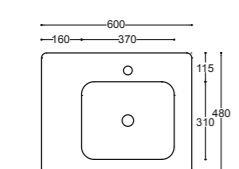
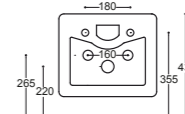
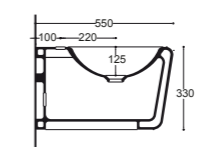

60

60X48

Lavabo Outline monoforo senza troppopieno
Outline one tap hole basin without overflow
Lavabo Outline para monomando sin rebosadero

- | | |
|--------------------|--------------------|
| 30351 white | 30480 white/yellow |
| 30476 black | 30482 white/green |
| 30481 white/cherry | 40106 black/bijoux |
| 30483 white/black | 40105 white/bijoux |

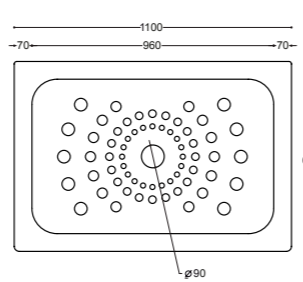
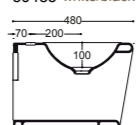
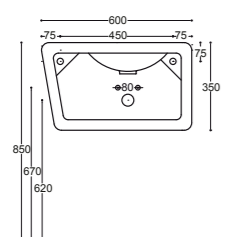

110

110x75

Piatto doccia Outline H 8,5 cm
Outline shower tray H 8,5 cm
Plato de ducha Outline H 8,5 cm

- | |
|--------------|
| 40171 white |
| 40172 black |
| 40174 yellow |
| 40175 green |
| 40173 cherry |

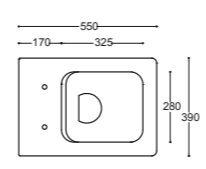

55

55X39

WC scarico a parete
WC wall trap
Inodoro salida H

- | |
|--------------------|
| 30343 white |
| 30378 black |
| 30442 white/cherry |
| 30444 white/black |
| 30441 white/yellow |
| 30443 white/green |
| 40120 black/bijoux |
| 40119 white/bijoux |

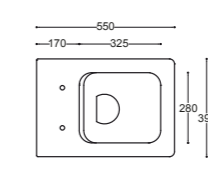
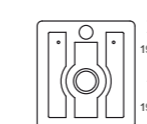
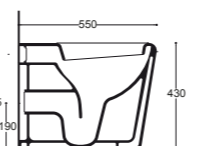

55

55X39

WC scarico a pavimento
WC floor trap
Inodoro salida V

- | |
|--------------------|
| 30548 white |
| 30559 black |
| 30557 white/cherry |
| 30555 white/black |
| 30554 white/yellow |
| 30556 white/green |
| 40122 black/bijoux |
| 40121 white/bijoux |

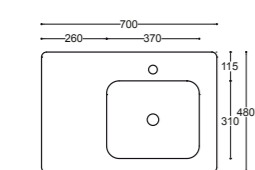
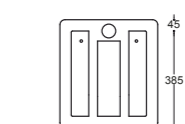
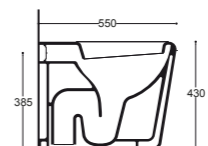

70

70X48

Lavabo Outline monoforo senza troppopieno
Outline one tap hole basin without overflow
Lavabo Outline para monomando sin rebosadero

- | | |
|--------------------|--------------------|
| 30350 white | 30472 white/yellow |
| 30428 black | 30474 white/green |
| 30473 white/cherry | 40108 black/bijoux |
| 30475 white/black | 40107 white/bijoux |

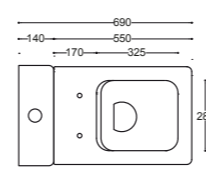
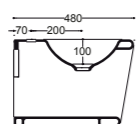
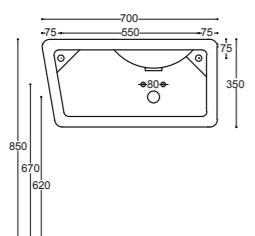

69

69X40

WC scarico a parete
WC wall trap
Inodoro salida H

- | | |
|--------------------|--------------------|
| 30343 white | 30441 white/yellow |
| 30378 black | 30443 white/green |
| 30442 white/cherry | 40120 black/bijoux |
| 30444 white/black | 40119 white/bijoux |

WC scarico a pavimento
WC floor trap
Inodoro salida V

- | | |
|--------------------|--------------------|
| 30548 white | 30554 white/yellow |
| 30559 black | 30556 white/green |
| 30557 white/cherry | 40122 black/bijoux |
| 30555 white/black | 40121 white/bijoux |

Totem Outline con meccanismo di scarico Geberit
Totem Outline with Geberit mechanism
Totem Outline con mecanismo de descarga Geberit

- | |
|-------------|
| 40203 white |
| 40204 black |

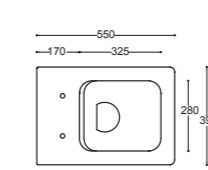
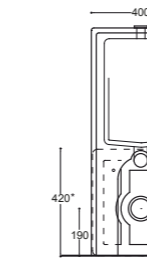
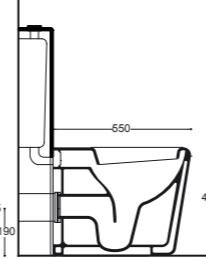

55

55X39

WC sospeso
Wall hung WC
Inodoro suspendido

- | |
|--------------------|
| 30345 white |
| 30431 black |
| 30451 white/cherry |
| 30453 white/black |
| 30450 white/yellow |
| 30452 white/green |
| 40126 black/bijoux |
| 40125 white/bijoux |

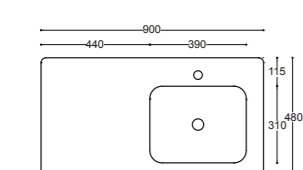
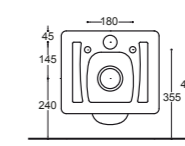
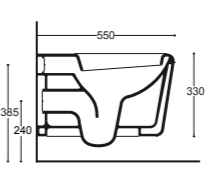

90

90X48

Lavabo Outline monoforo senza troppopieno
Outline one tap hole basin without overflow
Lavabo Outline para monomando sin rebosadero

- | | |
|--------------------|--------------------|
| 30349 white | 30466 white/yellow |
| 30377 black | 30468 white/green |
| 30467 white/cherry | 40110 black/bijoux |
| 30469 white/black | 40109 white/bijoux |

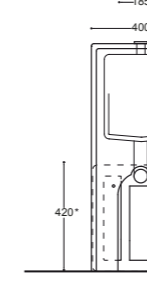
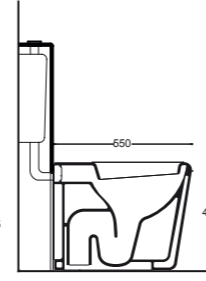
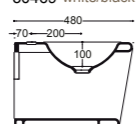
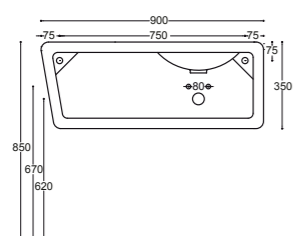

Articoli supplementari Additional items Artículos adicionales

- | | |
|--|----------------------------|
| Coprivaso in resina termoindurente
Thermosetting resin seat cover
Asiento de resina termoindurente | 30347 white
30503 black |
| Coprivaso frizionato in resina termoindurente
Thermosetting resin soft close seat cover
Asiento amortiguado de resina termoindurente | 40162 white
40163 black |
| Staffa di fissaggio per vaso e bidet sospesi
Bracket for wall hung WC - bidet
Estrubo a "L" para inodoro - bidé suspendidos | 30019 |
| Curva tecnica
Pipe fitting
Codo | 030070 |
| Kit piletta pop-up e sifone per lavabo-bidet
Pop-up and siphon set for basin and bidet
Kit válvula y sifón para lavabo-bidé | 30356 |



Consumo d'acqua
Water flush
Consumo de agua

Installazione:
Installation:
Instalación:



Installazione:
Installation:
Instalación:



Appoggio su pavimento
Standard shower tray
De apoyo al pavimento



DESIGNPREIS 2009
NOMINEE



50
50x48
Lavabo D-Style monoforo con troppopieno
D-Style one tap hole basin with overflow
Lavabo D-Style para monomando con rebosadero
40037 white

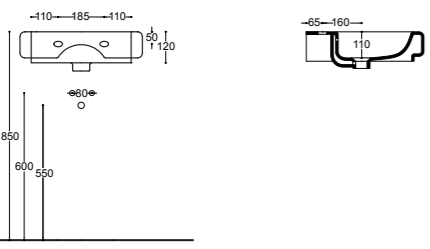

70
70x48
Lavabo D-Style monoforo senza troppopieno
D-Style one tap hole basin without overflow
Lavabo D-Style para monomando sin rebosadero
40038 white

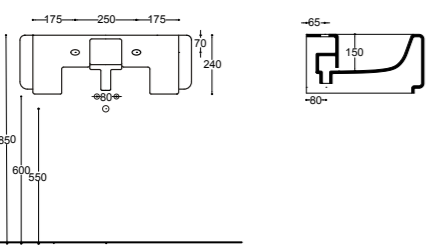

90
90x48
Lavabo D-Style monoforo senza troppopieno
D-Style one tap hole basin without overflow
Lavabo D-Style para monomando sin rebosadero
40039 white

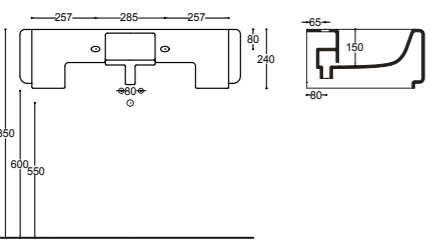

53
53x37
Bidet monoforo con troppopieno
One tap hole bidet with overflow
Bidé para monomando con rebosadero
40035 white

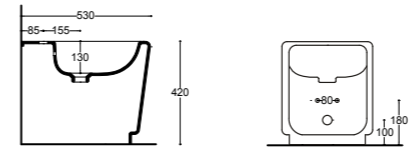

53
53x37
WC scarico pavimento - parete
WC floor - wall trap
Inodoro salida V/H
40031 white

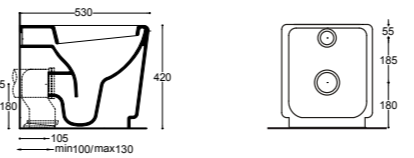

67
67x40
WC scarico pavimento - parete
WC floor - wall trap
Inodoro salida V/H
40031 white
Totem Soft con meccanismo di scarico Geberit
Totem Soft with Geberit mechanism
Totem Soft con mecanismo de descarga Geberit
40203 white
40204 black

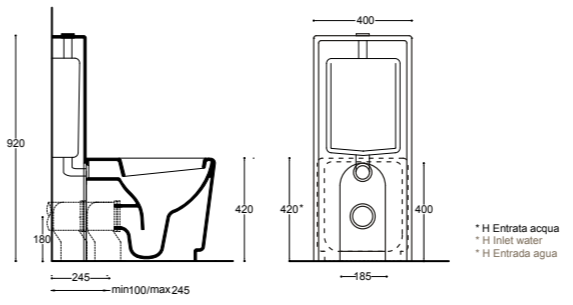

Porta oggetti da semincasso
Built in object holder
Estante semi encastre cuadrado
40028 white 40087 green
40086 black 40085 cherry
40088 yellow 40283 platinum

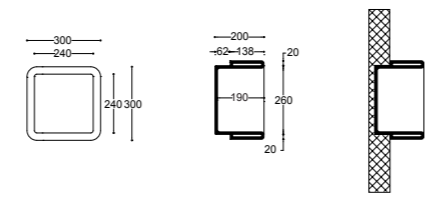

Portacarta da semincasso
Built in paper holder
Portapapel semi encastre
40027 white 40083 green
40049 black 40048 cherry
40084 yellow 40284 platinum

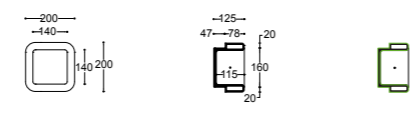

Portasalvietta cm 14
Towel bar cm 14
Toallero cm 14
40098 white 40101 green
40100 black 40099 cherry
40102 yellow 40287 platinum

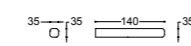

Portasalvietta cm 8
Towel bar cm 8
Toallero cm 8
40091 green 40091 green
40029 white 40089 cherry
40090 black 40089 cherry
40092 yellow 40286 platinum

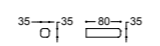

Portascopino
Toilet brush holder
Escobillero
40026 white 40046 green
40045 black 40044 cherry
40047 yellow 40285 platinum

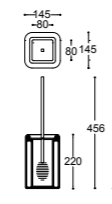

53
53x37
Bidet sospeso monoforo con troppopieno
Wall hung one tap hole bidet with overflow
Bidé suspendido para monomando con rebosadero
40036 white

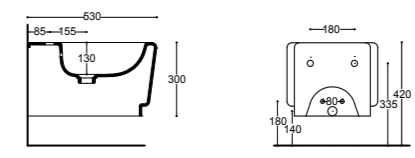

53
53x37
WC sospeso
Wall hung WC
Inodoro suspendido
40032 white

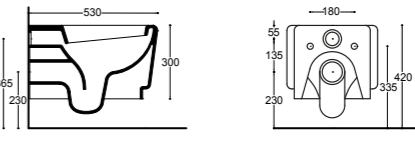

Articoli supplementari Additional items Artículos adicionales

Coprivaso in resina termoindurente Thermosetting resin seat cover Asiento de resina termoindurente	40030 white
Coprivaso frizionato in resina termoindurente Thermosetting resin soft close seat cover Asiento amortiguado de resina termoindurente	40139 white
Staffa di fissaggio per vaso e bidet sospesi Bracket for wall hung WC - bidet Estribo a "L" para inodoro - bidé suspendidos	30019
Staffa di fissaggio in plastica vaso e bidet Plastic bracket for WC - bidet Estribo en plástico para inodoro - bidé	40290
Curva tecnica Pipe fitting Codo	030070
Fissaggi per lavabo Fixings for washbasin Anclajes para lavabo	30020
Sifone Siphon Sifón	31056



Consumo d'acqua
Water flush
Consumo de agua

Installazione:
Installation:
Instalación:



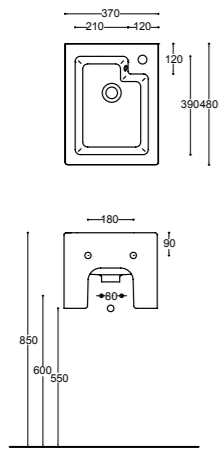

37
37x48 23
 Lavabo Compact monoforo con troppopieno
 Compact one tap hole basin with overflow
 Lavabo Compact para monomando con rebosadero
 40059 white
 40061 black

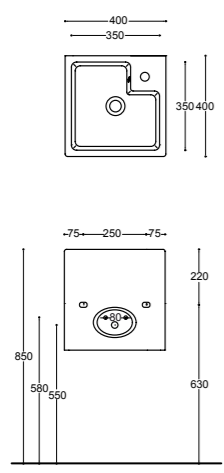

40
40x40 27
 Lavabo Cube monoforo con troppopieno
 Cube one tap hole basin with overflow
 Lavabo Cube para monomando con rebosadero
 40050 white
 40052 black

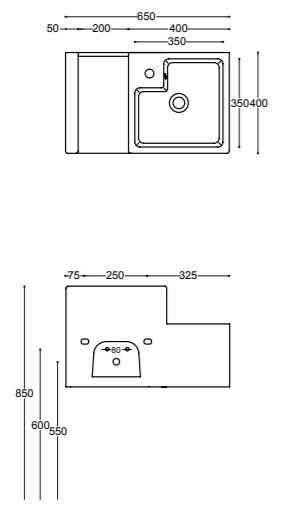

65
65x40 38
 Lavabo Medium monoforo con troppopieno
 Medium one tap hole basin with overflow
 Lavabo Medium para monomando con rebosadero
 40053 white
 40055 black

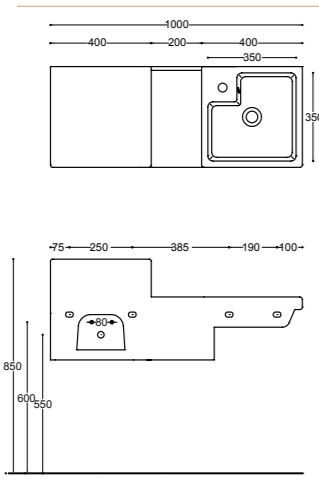

100
100x40 43
 Lavabo Large monoforo con troppopieno
 Large one tap hole basin with overflow
 Lavabo Large para monomando con rebosadero
 40056 white
 40058 black

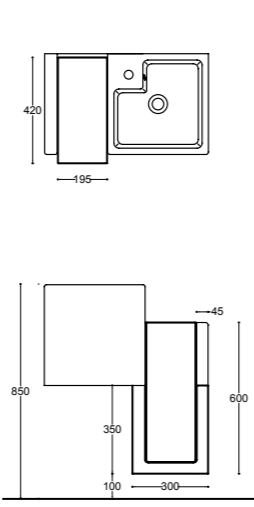

65
65x42 56
 Kit Lavabo Medium + Mobile sospeso
 Kit Medium basin + Wall hung furniture
 Kit Lavabo Medium + Mueble suspendido
 40181 white/white
 40177 white/cherry
 40180 white/black
 40179 white/yellow
 40178 white/green
 40182 black/black
 40183 black/white

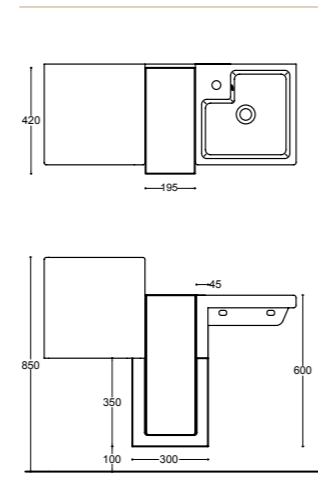

100
100x42 64
 Kit Lavabo Large + Mobile sospeso
 Kit Large basin + Wall hung furniture
 Kit Lavabo Large + Mueble suspendido
 40188 white/white
 40184 white/cherry
 40187 white/black
 40186 white/yellow
 40185 white/green
 40189 black/black
 40190 black/white

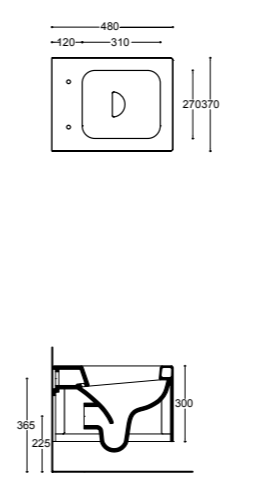

48
48x37 23
 WC sospeso
 Wall hung WC
 Inodoro suspendido
 40062 white
 40064 black

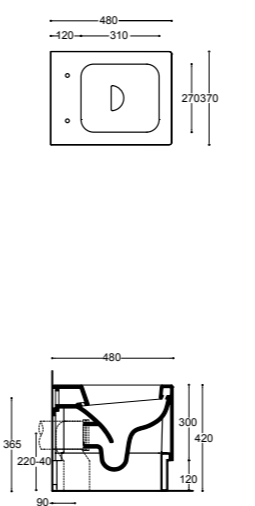

48
48x37 31
 WC sospeso scarico pavimento - parete
 Wall hung WC floor-wall trap
 Inodoro suspendido salida V/H
 40062 white
 40064 black
+
 Base double system
 Double system base
 Base double system
 40070 white
 40072 black
 40071 yellow
 40074 green
 40073 cherry

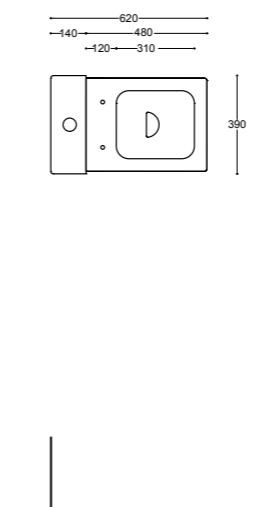

48
48x40 49
 WC sospeso scarico pavimento - parete
 Wall hung WC floor-wall trap
 Inodoro suspendido salida V/H
 40062 white
 40064 black
+
 Base double system
 Double system base
 Base double system
 40070 white
 40072 black
 40071 yellow
 40074 green
 40073 cherry
+
 Totem Hard con meccanismo di scarico Geberit
 Totem Hard with Geberit mechanism
 Totem Hard con mecanismo de descarga Geberit
 40201 white
 40202 black

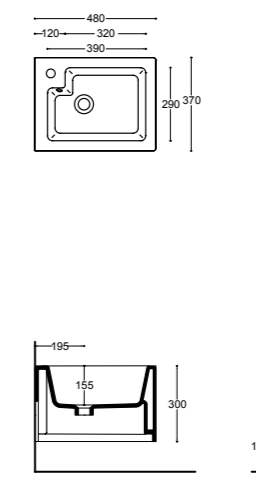
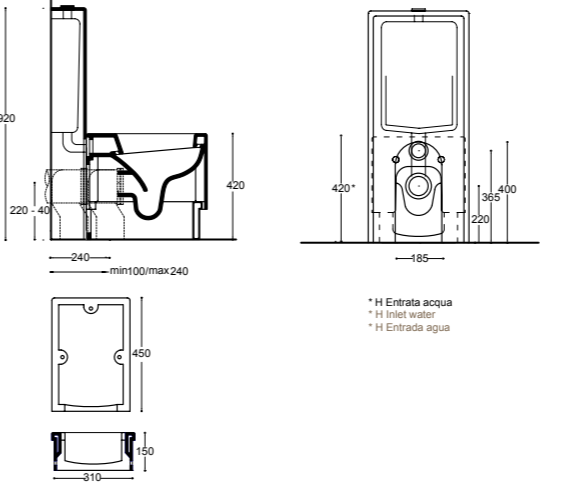

48
48x37 23
 Bidet sospeso monoforo con troppopieno
 Wall hung one tap hole bidet with overflow
 Bidé suspendido para monomando con rebosadero
 40059 white
 40061 black

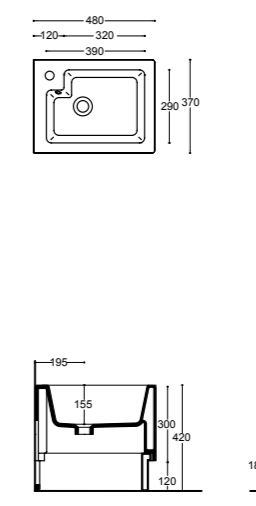

48
48x37 23
 Bidet sospeso monoforo con troppopieno
 Wall hung one tap hole bidet with overflow
 Bidé suspendido para monomando con rebosadero
 40059 white
 40061 black
+
 Base double system
 Double system base
 Base double system
 40070 white
 40072 black
 40071 yellow
 40074 green
 40073 cherry

- Articoli supplementari**
Additional items
Artículos adicionales
- Coprivaso in resina termoindurente 40065 white
 Thermosetting resin seat cover 40067 black
 Asiento de resina termoindurente
 - Coprivaso frizionato in resina termoindurente 40140 white
 Thermosetting resin soft close seat cover 40150 black
 Asiento amortiguado de resina termoindurente
 - Staffa di fissaggio per vaso e bidet sospesi 30019
 Bracket for wall hung WC - bidet
 Estribo a "L" para inodoro - bidé suspendidos
 - Staffa di fissaggio in plastica vaso e bidet 40290
 Plastic bracket for WC - bidet
 Estribo en plastico para inodoro - bidé
 - Curva tecnica 030070
 Pipe fitting
 Codo
 - Fissaggi per lavabo 30020
 Fixings for washbasin
 Anclajes para lavabo
 - Porta salviette in acciaio per lavabo Large 40141
 Steel towel bar for Large basin
 Toallero en acero inox para lavabo Large

Consumo d'acqua
 Water flush
 Consumo de agua

Installazione:
 Installation:
 Instalación:

- Sospeso
 Wall hung
 Suspendido
- Appoggio
 Sit on top
 Apoyo
- Su colonna
 With pedestal
 Con pedestal
- Con piedini
 With legs
 Con patas
- Sottopiano
 Under-counter
 Bajo encimera
- Semincasso
 Semi recessed
 Semiencastre
- Su mobile
 Cabinet basin
 Con mueble

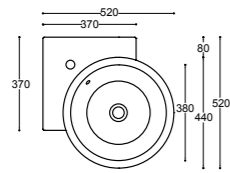

52
52x52

Lavabo Corner monoforo con troppopieno
Corner one tap hole basin with overflow
Lavabo Corner para monomando con rebosadero
31009 white

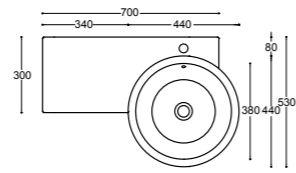
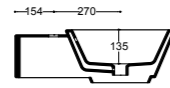
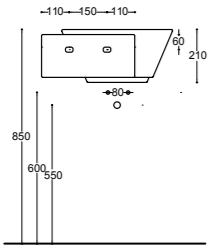

78
78x53

Lavabo Uno SX monoforo con troppopieno
Uno winged left hand one tap hole basin with overflow
Lavabo Uno lqzda para monomando con rebosadero
31011 white

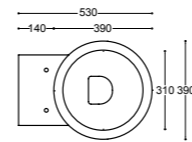
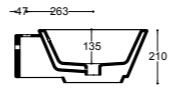
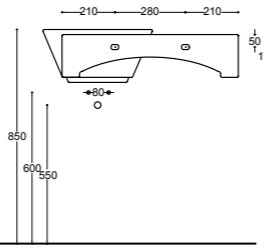

53
53x39

WC scarico pavimento parete
WC floor - wall trap
Inodoro salda V/H
31004 white

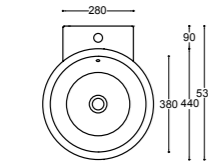
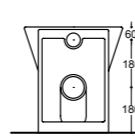
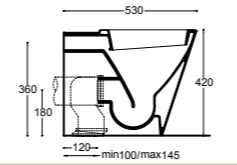

44
44x53

Lavabo Center monoforo con troppopieno
Center one tap hole basin with overflow
Lavabo Center para monomando con rebosadero
31074 white

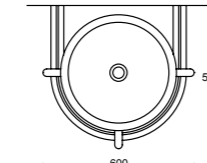
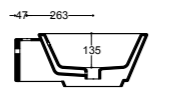
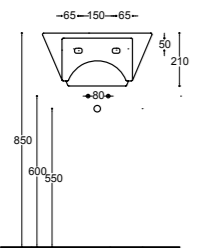

60
60x57

Lavabo Kono freestanding con troppopieno e struttura in acciaio
Kono freestanding basin with overflow and steel structure
Lavabo Kono freestanding con rebosadero y estructura en acero
31021 white
30420 black

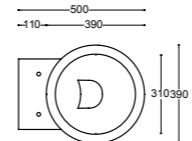
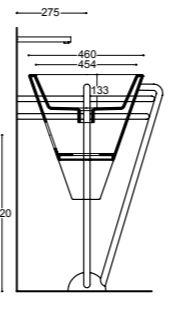
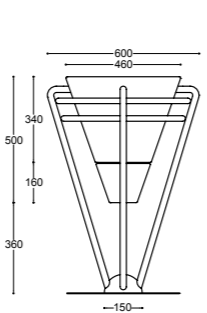

50
50x39

WC sospeso
Wall hung WC
Inodoro sospeso
31051 white

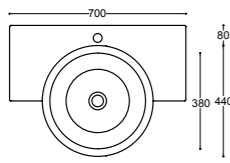
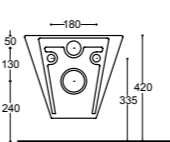
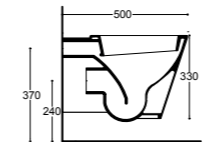

70
70x53

Lavabo Due monoforo con troppopieno
Due one tap hole basin with overflow
Lavabo Due para monomando con rebosadero
31008 white

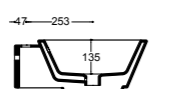
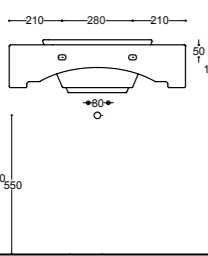

Articoli supplementari per lavabi Additional items for basins Artículos adicionales para lavabos

Fissaggi per lavabo Fixings for washbasin Anclajes para lavabo	30020
Sifone Siphon Sifon	31056
Gamba di supporto singola H cm 67 Single leg H cm 67 Soporte individual H cm 67	31059 acciaio - steel - acero
Coppia gambe di supporto H cm 67 Pair of legs H cm 67 Pareja soportes H cm 67	31060 acciaio - steel - acero

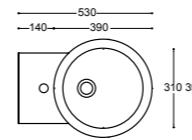

53
53x39

Bidet monoforo con troppopieno
One tap hole bidet with overflow
Bidé para monomando con rebosadero
31040 white

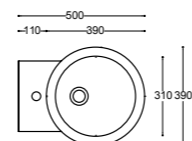
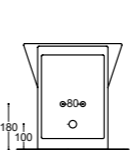
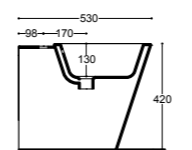

50
50x39

Bidet sospeso monoforo con troppopieno
Wall hung one tap hole bidet with overflow
Bidé suspendido para monomando con rebosadero
31042 white

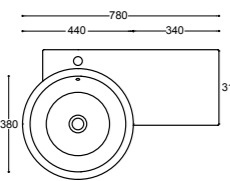
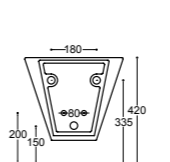
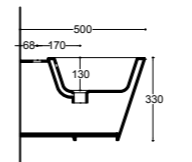

78
78x53

Lavabo Uno DX monoforo con troppopieno
Uno winged right hand one tap hole basin with overflow
Lavabo Uno Dcha para monomando con rebosadero
31010 white

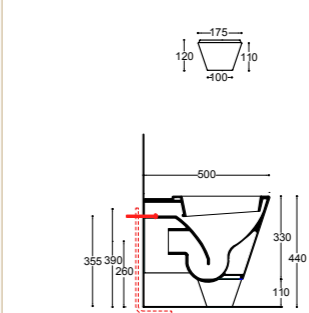
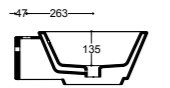
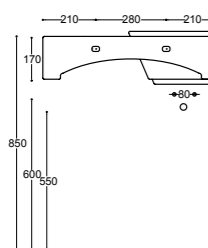

Supporto in ceramica per sanitari sospesi
Ceramic support for wall hung sanitary ware
Soporte en cerámica para sanitarios suspendidos
31049 white
Staffa di fissaggio per vaso e bidet sospesi
Bracket for wall hung WC bowl - bidet
Estribo a "L" para inodoro - bidé suspendidos
30019

Esempio installazione vaso e bidet semisospesi - Utilizzare staffa di fissaggio vaso / bidet sospesi
Installation example semi wall hung WC bowl and bidet - Use bracket for wall hung WC bowl / bidet
Ejemplo instalación inodoro y bidé semi suspendidos - Utilizar el estribo para inodoro / bidé suspendidos

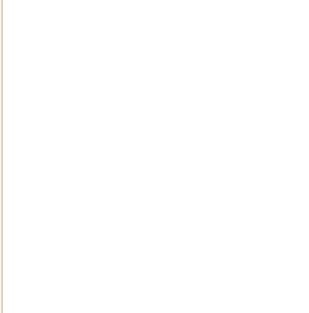

Supporto in ceramica per sanitari sospesi
Ceramic support for wall hung sanitary ware
Soporte en cerámica para sanitarios suspendidos
31049 white
Staffa di fissaggio per vaso e bidet sospesi
Bracket for wall hung WC bowl - bidet
Estribo a "L" para inodoro - bidé suspendidos
30019

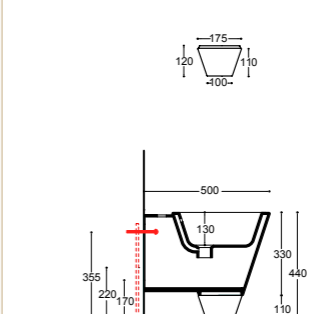

Supporto in ceramica per sanitari sospesi
Ceramic support for wall hung sanitary ware
Soporte en cerámica para sanitarios suspendidos
31049 white
Staffa di fissaggio per vaso e bidet sospesi
Bracket for wall hung WC bowl - bidet
Estribo a "L" para inodoro - bidé suspendidos
30019

Esempio installazione vaso e bidet semisospesi - Utilizzare staffa di fissaggio vaso / bidet sospesi
Installation example semi wall hung WC bowl and bidet - Use bracket for wall hung WC bowl / bidet
Ejemplo instalación inodoro y bidé semi suspendidos - Utilizar el estribo para inodoro / bidé suspendidos

Installazione:
Installation:
Instalación:



Sospeso
Wall hung
Suspendido



Appoggio
Sit on top
Apoyo



Su colonna
With pedestal
Con pedestal



Con piedini
With legs
Con patas



Sottopiano
Under-counter
Bajo encimera



Semincasso
Semi recessed
Semiencastré

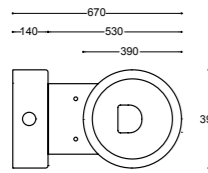

Su mobile
Cabinet basin
Con mueble

**67****67x40**

WC scarico pavimento - parete
 WC floor - wall trap
 Inodoro salida V/H
 31004 white

+

Totem Hard con meccanismo di scarico Geberit
 Totem Hard with Geberit mechanism
 Totem Hard con mecanismo de descarga Geberit
 40201 white
 40202 black

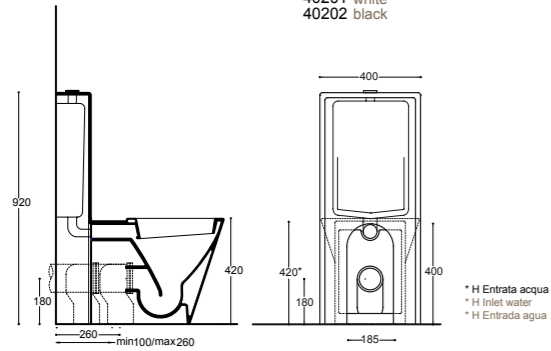

* H Entrata acqua
 * H Inlet water
 * H Entrada agua

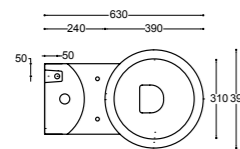
**63****63x39**

WC monoblocco scarico pavimento - parete
 Close-coupled WC floor - wall trap
 Inodoro para tanque bajo salida V/H
 31001 white

Cassetta monoblocco entrata acqua alta
 Close-coupled cistern high inlet water
 Tanque bajo entrada agua alta

31014 white

+

Meccanismo di scarico entrata acqua alta
 Mechanism high inlet water
 Mecanismo de descarga entrada agua alta
 31091

Cassetta monoblocco entrata acqua inferiore
 Close-coupled cistern inferior inlet water
 Tanque bajo entrada agua inferior

40128 white

+

Meccanismo di scarico entrata acqua inferiore
 Mechanism inferior inlet water
 Mecanismo de descarga entrada agua inferior
 40195

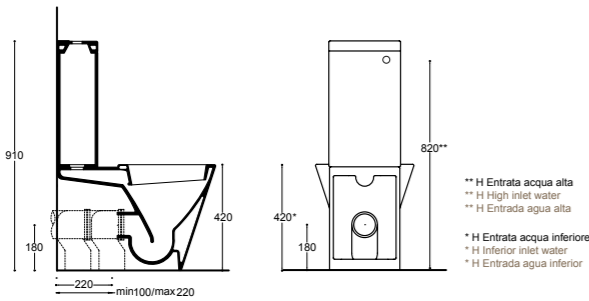

** H Entrata acqua alta
 ** H High inlet water
 ** H Entrada agua alta

* H Entrata acqua inferiore
 * H Inferior inlet water
 * H Entrada agua inferior

Articoli supplementari per sanitari

Additional items for sanitary ware

Artículos adicionales para sanitarios

Coprivaso in resina termoindurente 31050 white
 Thermosetting resin seat cover 40165 black
 Asiento de resina termoindurente 31067 silver

Staffa di fissaggio per vaso e bidet sospesi 30019
 Bracket for wall hung WC - bidet
 Estribo a "L" para inodoro - bidé suspendidos

Staffa di fissaggio in plastica vaso e bidet 40290
 Plastic bracket for WC - bidet
 Estribo en plástico para inodoro - bidé

Curva tecnica 030070
 Pipe fitting
 Codo



Sospeso
 Wall hung
 Suspendido



Appoggio
 Sit on top
 Apoyo



Su colonna
 With pedestal
 Con pedestal



Con piedini
 With legs
 Con patas



Sottopiano
 Under-counter
 Bajo encimera



Semincasso
 Semi recessed
 Semiencastré



Su mobile
 Cabinet basin
 Con mueble

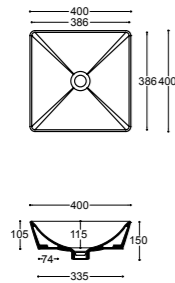

40
40x40  **7**
 Lavabo d'appoggio Neo senza troppopieno
 Neo sit on top basin without overflow
 Lavabo de apoyo Neo sin rebosadero
 30117 white
 30144 black
 30142 yellow
 30143 grey
 30141 cherry

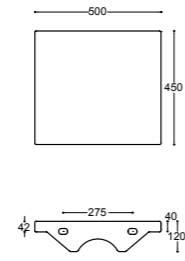

50
50x45  **12**
 Mensola cm 50
 Shelf cm 50
 Repisa cm 50
 30100 white
 30313 black
 30311 yellow
 30312 grey
 30310 cherry

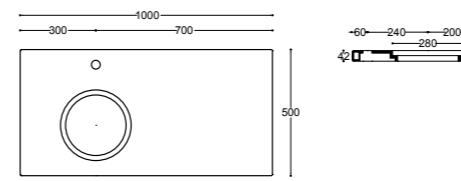

100
100x50  **20**
 Piastra Elle cm 100
 Elle cm 100 slab counter
 Encimera Elle cm 100
 30121 white
 30164 black
 Fissaggio piastra Elle cm 100
 Elle cm 100 slab counter fixing set
 Anclaje encimera Elle cm 100
 30103

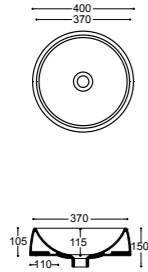

40
40x40  **7**
 Lavabo d'appoggio Kali senza troppopieno
 Kali sit on top basin without overflow
 Lavabo de apoyo Kali sin rebosadero
 30118 white
 30149 black
 30147 yellow
 30148 grey
 30146 cherry

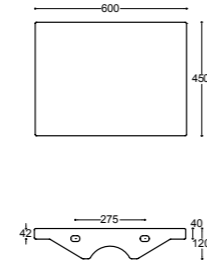

60
60x45  **13**
 Mensola cm 60
 Shelf cm 60
 Repisa cm 60
 30102 white
 30319 black
 30317 yellow
 30318 grey
 30316 cherry

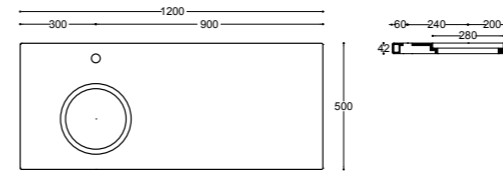

120
120x50  **23**
 Piastra Elle cm 120
 Elle cm 120 slab counter
 Encimera Elle cm 120
 30122 white
 30169 black
 Fissaggio piastra Elle cm 120
 Elle cm 120 slab counter fixing set
 Anclaje encimera Elle cm 120
 30104

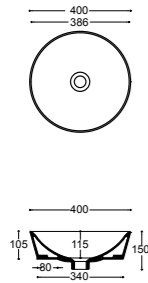

40
40x40  **7**
 Lavabo d'appoggio Tecno senza troppopieno
 Tecno sit on top basin without overflow
 Lavabo de apoyo Tecno sin rebosadero
 30119 white
 30154 black
 30152 yellow
 30153 grey
 30151 cherry

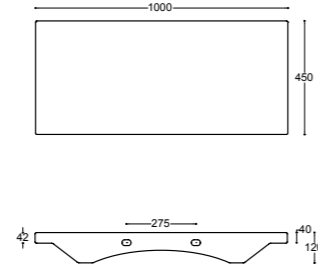

100
100x45  **23**
 Mensola cm 100
 Shelf cm 100
 Repisa cm 100
 30101 white
 30325 black
 30323 yellow
 30324 grey
 30322 cherry

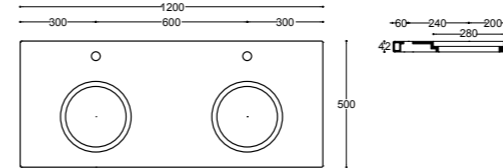

120
120x50  **22**
 Piastra Elle cm 120 Duo
 Elle cm 120 Duo slab counter
 Encimera Elle cm 120 Duo
 30123 white
 30174 black
 Fissaggio piastra Elle cm 120
 Elle cm 120 slab counter fixing set
 Anclaje encimera Elle cm 120
 30104

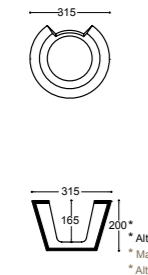

31
31x30  **4**
 Semicolonna Tecno
 Tecno half pedestal
 Semipedestal Tecno
 30120 white
 30159 black
 30157 yellow
 30158 grey
 30156 cherry



100
100x45  **23**
 Mensola cm 100
 Shelf cm 100
 Repisa cm 100
 30101 white
 30325 black
 30323 yellow
 30324 grey
 30322 cherry

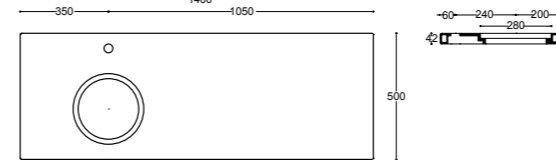

140
140x50  **28**
 Piastra Elle cm 140
 Elle cm 140 slab counter
 Encimera Elle cm 140
 30124 white
 30179 black
 Fissaggio piastra Elle cm 140
 Elle cm 140 slab counter fixing set
 Anclaje encimera Elle cm 140
 30105

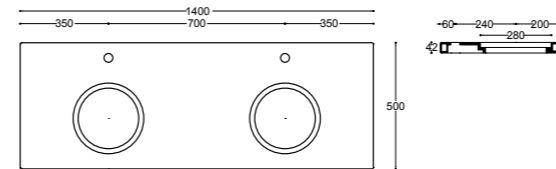

140
140x50  **27**
 Piastra Elle cm 140 Duo
 Elle cm 140 Duo slab counter
 Encimera Elle cm 140 Duo
 30125 white
 30184 black
 Fissaggio piastra Elle cm 140
 Elle cm 140 slab counter fixing set
 Anclaje encimera Elle cm 140
 30105

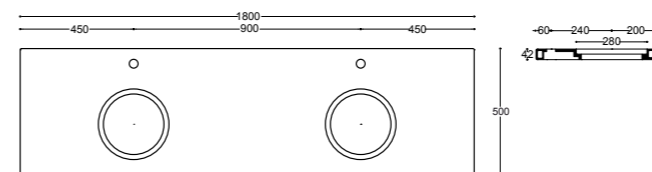

180
180x50  **33**
 Piastra Elle cm 180 Duo
 Elle cm 180 Duo slab counter
 Encimera Elle cm 180 Duo
 30126 white
 30189 black
 Fissaggio piastra Elle cm 180
 Elle cm 180 slab counter fixing set
 Anclaje encimera Elle cm 180
 30106

Articoli supplementari
 Additional items
 Artículos adicionales

Sifone ribassato Short siphon Sifón corto	40170
Sifone Siphon Sifón	31056

Installazione:
 Installation:
 Instalación:

-  **Sospeso**
Wall hung
Suspendido
-  **Appoggio**
Sit on top
Apoyo
-  **Su colonna**
With pedestal
Con pedestal
-  **Con piedini**
With legs
Con patas
-  **Sottopiano**
Under-counter
Bajo encimera
-  **Semincasso**
Semi recessed
Semiencastrado
-  **Su mobile**
Cabinet basin
Con mueble

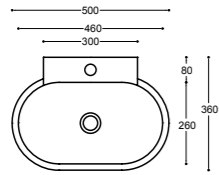

50

50x36



Lavabo Easy Small monoforo con troppopieno
 Easy Small one tap hole basin with overflow
 Lavabo Easy Small para monomando con rebosadero
 30076 white
 30301 black
 30303 yellow
 30302 cherry

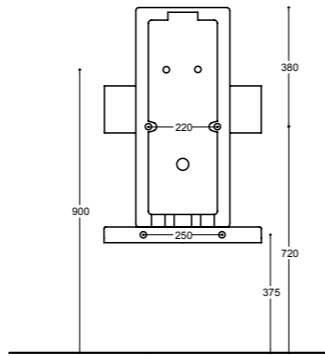
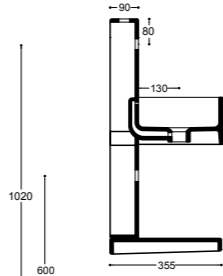
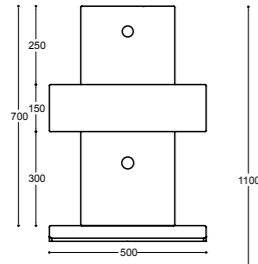

Installazione:
 Installation:
 Instalación:



Sospeso
 Wall hung
 Suspendingido



Appoggio
 Sit on top
 Apoyo



Su colonna
 With pedestal
 Con pedestal



Con piedini
 With legs
 Con patas



Sottopiano
 Under-counter
 Bajo encimera



Semincasso
 Semi recessed
 Semiencastré



Su mobile
 Cabinet basin
 Con mueble

45

45X45

10 KG

Lavabo monoforo angolare con troppopieno
 Corner one tap hole basin with overflow
 Lavabo Angular para monomando con rebosadero

30353 white
 40769 black

85

85X45

23 KG

Consolle cm 85 monoforo con troppopieno
 One tap hole Console cm 85 with overflow
 Consola cm 85 para monomando con rebosadero

30355 white
 40772 black

57

57X36

17 KG

Bidet monoforo con troppopieno
 One tap hole bidet with overflow
 Bidé para monomando con rebosadero

27040 white
 40776 black

Bidet tre fori con troppopieno
 Three tap hole bidet with overflow
 Bidé tres agujeros con rebosadero

27040-3F white
 40776-3F black

56

56X45

11 KG

Lavabo monoforo con troppopieno
 One tap hole basin with overflow
 Lavabo para monomando con rebosadero

30354 white
 40770 black

105

105X45

25 KG

Consolle cm 105 monoforo con troppopieno
 One tap hole Console cm 105 with overflow
 Consola cm 105 para monomando con rebosadero

40127 white
 40773 black

55

55x36

19 KG

Water saving 3/4.5 L

WC scarico a parete
 WC wall trap
 Inodoro salida H

27003 white
 40777 black

55

55x36

17 KG

Water saving 3/4.5 L

WC scarico pavimento
 WC floor trap
 Inodoro salida V

27004 white
 40778 black

70

70X59

27 KG

Lavabo monoforo con troppopieno
 One tap hole basin with overflow
 Lavabo para monomando con rebosadero

27021 white 40771 black
 Lavabo tre fori con troppopieno
 Three tap hole basin with overflow
 Lavabo tres agujeros con rebosadero

27021-3F white 40771-3F black

110

110X61

32 KG

Consolle cm 110 monoforo con troppopieno
 One tap hole Console cm 110 with overflow
 Consola cm 110 para monomando con rebosadero

40129 white
 40774 black

71

71x47

30 KG

Water saving 3/4.5 L

WC Monoblocco scarico a parete
 Close - coupled WC wall trap
 Inodoro para tanque bajo salida H

27001 white
 40779 black

Cassetta monoblocco
 Close - coupled cistern
 Tanque bajo

27014 white
 40781 black

+
 Meccanismo di scarico
 Mechanism for close - coupled cistern
 Mecanismo de descarga

30090

71

71x47

30 KG

Water saving 3/4.5 L

WC Monoblocco scarico a pavimento
 Close - coupled WC floor trap
 Inodoro para tanque bajo salida V

27002 white
 40780 black

Cassetta monoblocco
 Close - coupled cistern
 Tanque bajo

27014 white
 40781 black

+
 Meccanismo di scarico
 Mechanism for close - coupled cistern
 Mecanismo de descarga

30090

63

63X32

14 KG

Colonna
 Pedestal
 Pedestal

27030 white
 40848 black

424
 royal

75

75X12

Piedini
 Legs
 Patas

40191 white
 40793 black
 40794 platinum
 40869 gold

83

83X12

Piedini
 Legs
 Patas

40408 white
 40787 black
 40788 platinum
 40789 gold

110

110X55

41 KG

Consolle Calipso monoforo con troppopieno
 One tap hole Console Calipso with overflow
 Consola Calipso para monomando con rebosadero

30060 white
 40775 black

* H Entrata acqua
 * H Inlet water
 * H Entrada agua

* H Entrata acqua
 * H Inlet water
 * H Entrada agua



Consumo d'acqua
 Water flush
 Consumo de agua

Installazione:
 Installation:
 Instalación:



Cassetta alta con coperchio
High level cistern with lid
Tanque alto con tapa
27013 white
40782 black

+

Set per cassetta alta (tubo+catenella+meccanismo)
Set for high level cistern (pipe+chain+mechanism)
Set para tanque alto(tubo+cadena+mec)
40166 chrome
40167 bronze

Set per cassetta alta (catenella+meccanismo)
Set for high level cistern (chain+mechanism)
Set para tanque alto(cadena+mec)
40168 chrome
40169 bronze

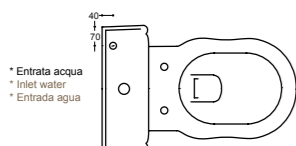
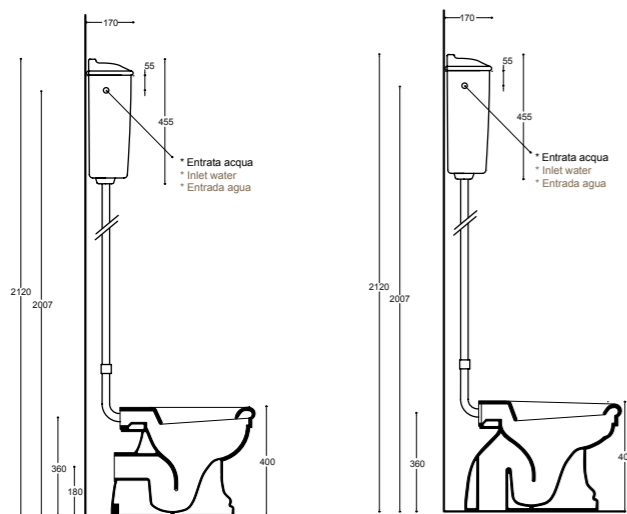

Cassetta a zaino
Low level cistern with lid
Tanque a media altura
40288 white
40783 black

Meccanismo di scarico per cassetta a zaino
Mechanism for low level cistern
Mecanismo de descarga para tanque a media altura
40289

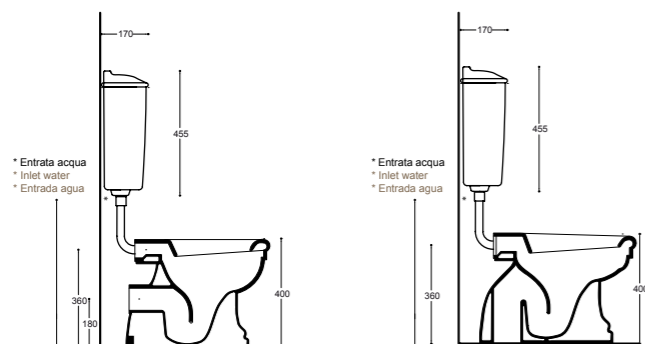

Articoli supplementari Additional items Artículos adicionales

Coprivaso in resina termoindurente
Thermosetting resin seat cover
Asiento de resina termoindurente
27050 white
27052 wood
40868 black

Cerniere cromo
Chrome hinges
Bisagras cromo

Coprivaso frizionato in resina termoindurente
Thermosetting resin soft close seat cover
Asiento amortiguado de resina termoindurente
40409 white
40412 wood
40870 black

Cerniere cromo
Chrome hinges
Bisagras cromo

Fissaggio per vaso e bidet
Fixings for WC - bidet
Anclajes para inodoro - bidé
520/A

Fissaggi per lavabo
Fixings for washbasin
Anclajes para lavabo
30020

170

170x80  60

Vasca Royal bianca con staffe e piedini - Installazione centro stanza
Royal bathtub with brackets and feet - Freestanding installation
Bañera Royal blanca con pie - Instalación freestanding

40859 white/chrome metal feet
40860 white/white metal feet
40861 white/bronze metal feet
40862 white/gold metal feet

Kit colonna scarico e sifone
Drain column and syphon kit
Kit tubo de descarga

40863 chrome metal kit
40864 white metal kit
40865 bronze metal kit
40866 gold metal kit

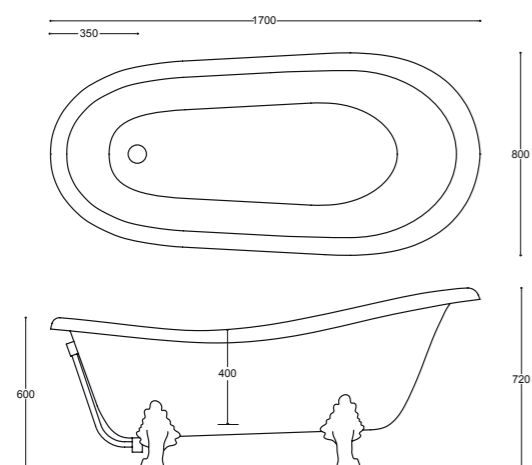

Consumo d'acqua
Water flush
Consumo de agua

Installazione:
Installation:
Instalación:



Sospeso
Wall hung
Suspendido



Appoggio
Sit on top
Apoyo



Su colonna
With pedestal
Con pedestal



Con piedini
With legs
Con patas



Sottopiano
Under-counter
Bajo encimera



Semincasso
Semi recessed
Semiencastré



Su mobile
Cabinet basin
Con mueble

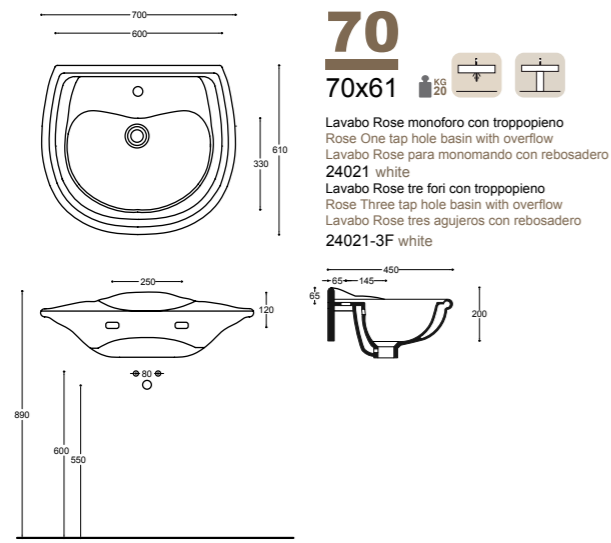

70

70x61 20

Lavabo Rose monoforo con troppopieno
Rose One tap hole basin with overflow
Lavabo Rose para monomando con rebosadero
24021 white
Lavabo Rose tre fori con troppopieno
Rose Three tap hole basin with overflow
Lavabo Rose tres agujeros con rebosadero
24021-3F white

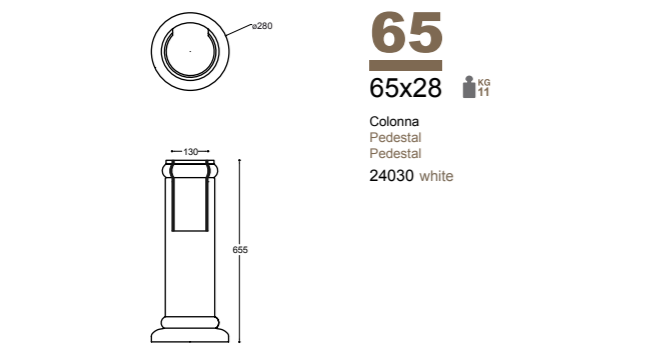

65

65x28 11

Colonna
Pedestal
Pedestal
24030 white

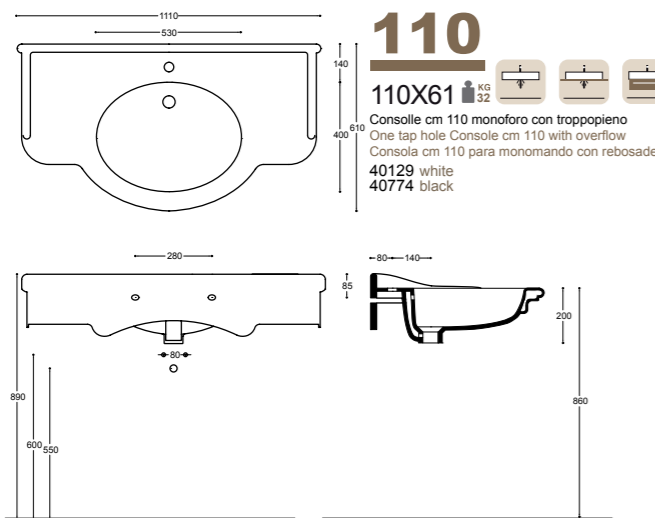

110

110x61 32

Consolle cm 110 monoforo con troppopieno
One tap hole Console cm 110 with overflow
Consola cm 110 para monomando con rebosadero
40129 white
40774 black

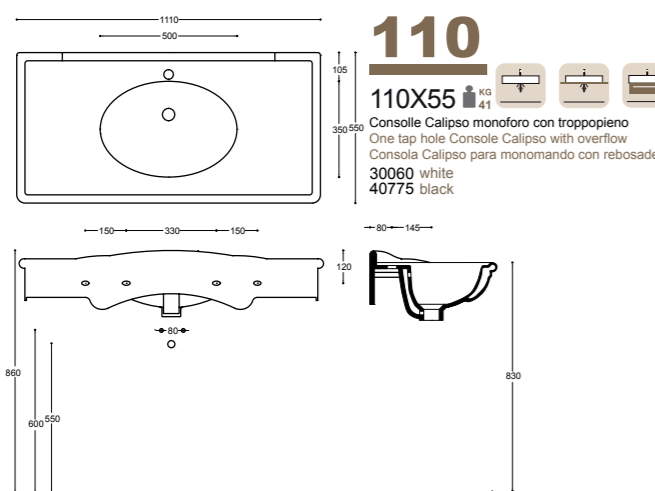

110

110x55 41

Consolle Calipso monoforo con troppopieno
One tap hole Console Calipso with overflow
Consola Calipso para monomando con rebosadero
30060 white
40775 black

428
rose

83

83x12

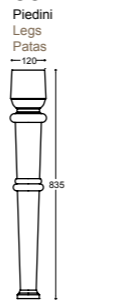

Piedini
Legs
Patas
40408 white
40787 black
40788 platinum
40789 gold

75

75x12

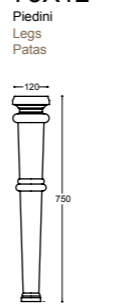

Piedini
Legs
Patas
40191 white
40793 black
40794 platinum
40869 gold

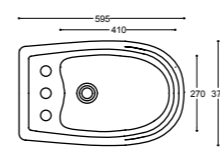

59

59x37 19

Bidet monoforo con troppopieno
One tap hole bidet with overflow
Bidé para monomando con rebosadero
24040 white
Bidet tre fori con troppopieno
Three tap hole bidet with overflow
Bidé tres agujeros con rebosadero
24040-3F white

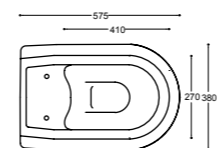
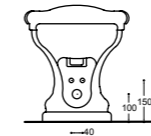
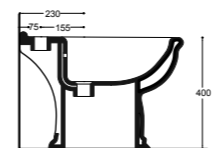

57

57x38 18

WC scarico a parete
WC wall trap
Inodoro salida H
24003 white

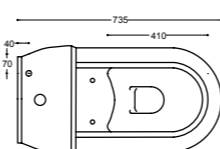
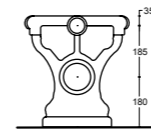

73

73x39 37

WC Monoblocco scarico a parete
Close - coupled WC wall trap
Inodoro para tanque bajo salida H

24001 white
Cassetta monoblocco
Close - coupled cistern
Tanque bajo
24014 white

+
Meccanismo di scarico
Mechanism for close - coupled cistern
Mecanismo de descarga
30090

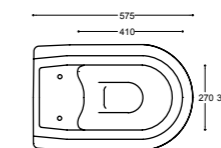
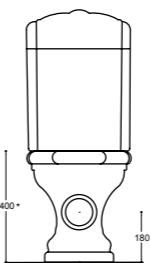
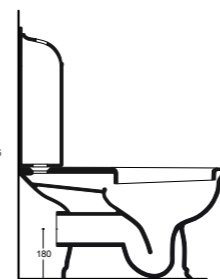

57

57x38 18

WC scarico a pavimento
WC floor trap
Inodoro salida V
24004 white

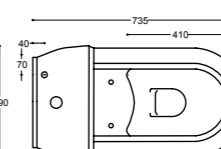
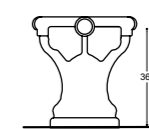
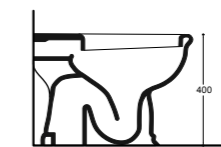

73

73x39 37

WC Monoblocco scarico a pavimento
Close - coupled WC floor trap
Inodoro para tanque bajo salida V

24002 white
Cassetta monoblocco
Close - coupled cistern
Tanque bajo
24014 white

+
Meccanismo di scarico
Mechanism for close - coupled cistern
Mecanismo de descarga
30090

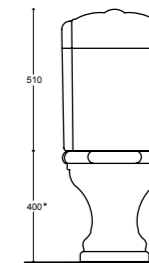
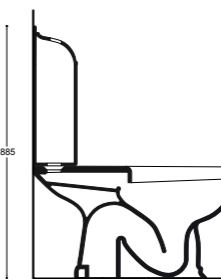

Articoli supplementari

Additional items Artículos adicionales

Coprivaso in resina termoindurente Thermosetting resin seat cover Asiento de resina termoindurente	24050 white 24052 wood	Cerniere cromo Chrome hinges Bisagras cromo
Coprivaso frizionato in resina termoindurente Thermosetting resin soft close seat cover Asiento amortiguado de resina termoindurente	40415 white 40418 wood	Cerniere cromo Chrome hinges Bisagras cromo
Fissaggi per vaso e bidet Fixings for WC - bidet Anclajes para inodoro - bidé	520/A	
Fissaggi per lavabo Fixings for washbasin Anclajes para lavabo	30020	

429
rose



Consumo d'acqua
Water flush
Consumo de agua

Installazione:
Installation:
Instalación:



Sospeso
Wall hung
Suspendido



Appoggio
Sit on top
Apoyo



Su colonna
With pedestal
Con pedestal



Con piedini
With legs
Con patas



Sottopiano
Under-counter
Bajo encimera



Semincasso
Semi recessed
Semiencastré



Su mobile
Cabinet basin
Con mueble

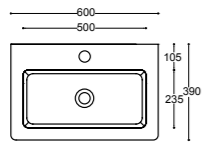

60

60X39 15 KG



Lavabo Smart monoforo con troppopieno
Smart one tap hole basin with overflow
Lavabo Smart para monomando con rebosadero
40132 white
40206 black

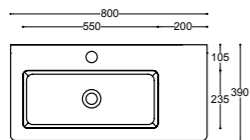
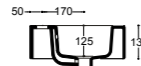
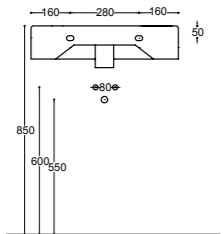

80

80X39 20 KG



Lavabo Smart monoforo con troppopieno
Smart one tap hole basin with overflow
Lavabo Smart para monomando con rebosadero
40137 white
40205 black

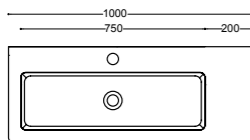
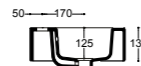
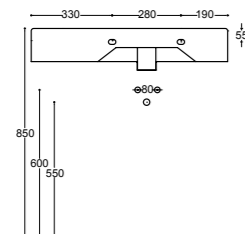

100

100X39 25 KG



Lavabo Smart monoforo con troppopieno
Smart one tap hole basin with overflow
Lavabo Smart para monomando con rebosadero
40138 white
40207 black

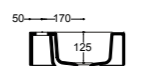
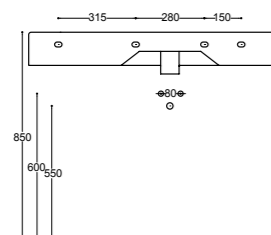

Articoli supplementari

Additional items

Artículos adicionales

Fissaggi per lavabo Fixings for washbasin Anclajes para lavabo	30020
Sifone Siphon Sifón	31056

Installazione:
Installation:
Instalación:



Sospeso
Wall hung
Suspendido



Appoggio
St on top
Apoyo



Su colonna
With pedestal
Con pedestal



Con piedini
With legs
Con patas



Sottopiano
Under-counter
Bajo encimera



Semincasso
Semi recessed
Semiencastré



Su mobile
Cabinet basin
Con mueble

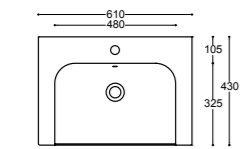

61

61x43



Lavabo Stilo monoforo con troppopieno
Stilo one tap hole basin with overflow
Lavabo Stilo para monomando con rebosadero
40356 white

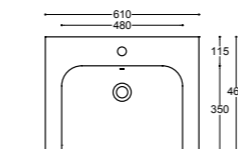
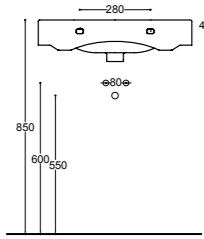

61

61x46



Lavabo Stilo monoforo con troppopieno
Stilo one tap hole basin with overflow
Lavabo Stilo para monomando con rebosadero
40482 white

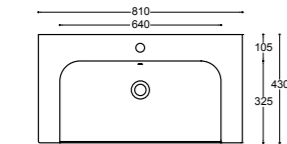
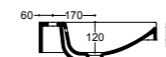
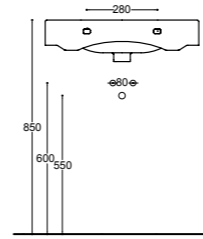

81

81x43



Lavabo Stilo monoforo con troppopieno
Stilo one tap hole basin with overflow
Lavabo Stilo para monomando con rebosadero
40357 white

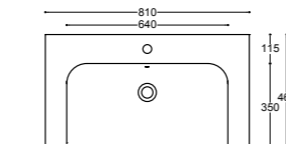
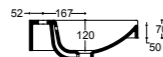
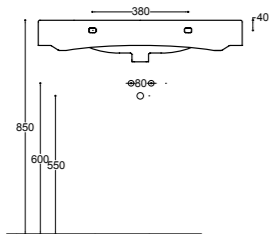

81

81x46



Lavabo Stilo monoforo con troppopieno
Stilo one tap hole basin with overflow
Lavabo Stilo para monomando con rebosadero
40483 white

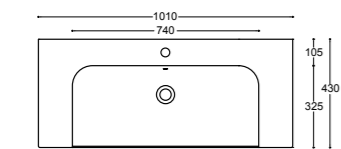
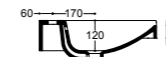
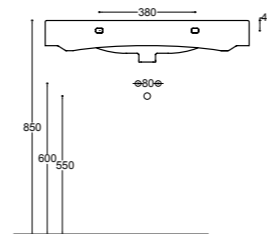

101

101x43



Lavabo Stilo monoforo con troppopieno
Stilo one tap hole basin with overflow
Lavabo Stilo para monomando con rebosadero
40358 white

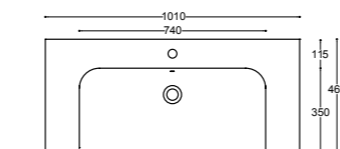
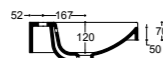
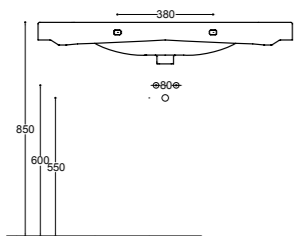

101

101x46



Lavabo Stilo monoforo con troppopieno
Stilo one tap hole basin with overflow
Lavabo Stilo para monomando con rebosadero
40484 white

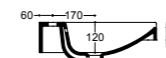
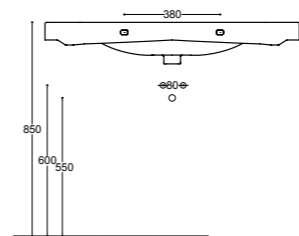

Articoli supplementari
Additional items
Artículos adicionales

Fissaggi per lavabo Fixings for washbasin Anclajes para lavabo	30020
Sifone Siphon Sifón	31056

Installazione:
Installation:
Instalación:



Sospeso
Wall hung
Suspendido



Appoggio
On top
Apoyo



Su colonna
With pedestal
Con pedestal



Con piedini
With legs
Con patas



Sottopiano
Under-counter
Bajo encimera



Semincasso
Semi recessed
Semiencastré



Su mobile
Cabinet basin
Con mueble

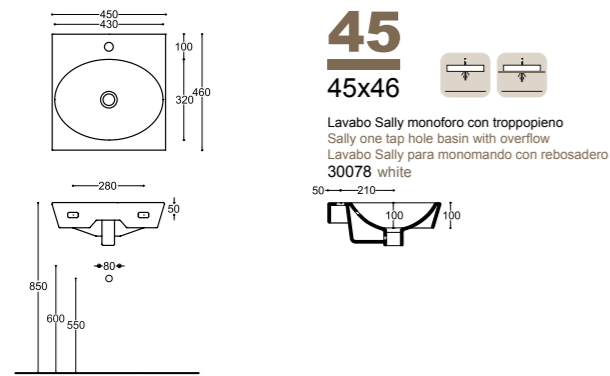

45
45x46
Lavabo Sally monoforo con troppopieno
Sally one tap hole basin with overflow
Lavabo Sally para monomando con rebosadero
30078 white

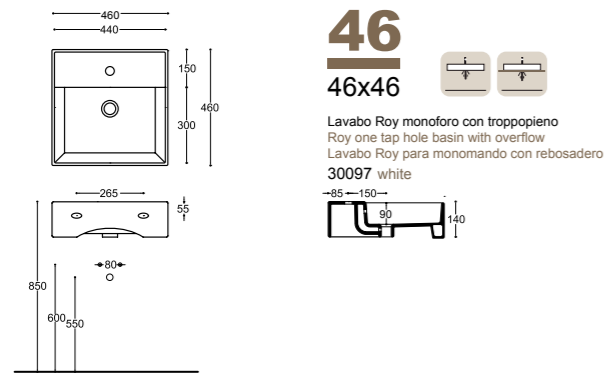

46
46x46
Lavabo Roy monoforo con troppopieno
Roy one tap hole basin with overflow
Lavabo Roy para monomando con rebosadero
30097 white

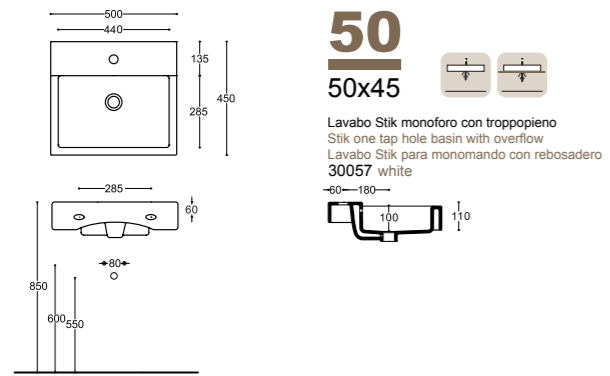

50
50x45
Lavabo Stik monoforo con troppopieno
Stik one tap hole basin with overflow
Lavabo Stik para monomando con rebosadero
30057 white

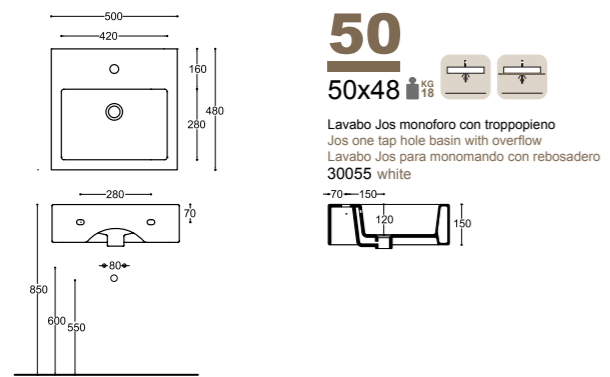

50
50x48
Lavabo Jos monoforo con troppopieno
Jos one tap hole basin with overflow
Lavabo Jos para monomando con rebosadero
30055 white

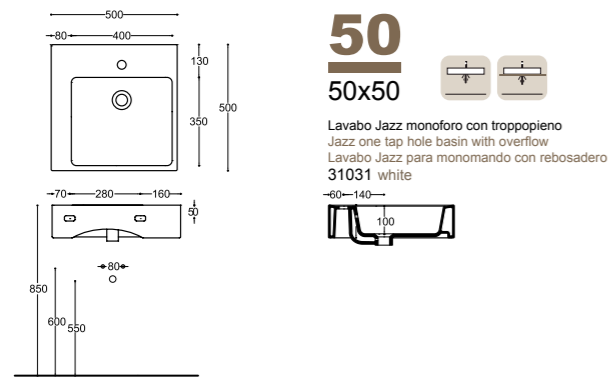

50
50x50
Lavabo Jazz monoforo con troppopieno
Jazz one tap hole basin with overflow
Lavabo Jazz para monomando con rebosadero
31031 white

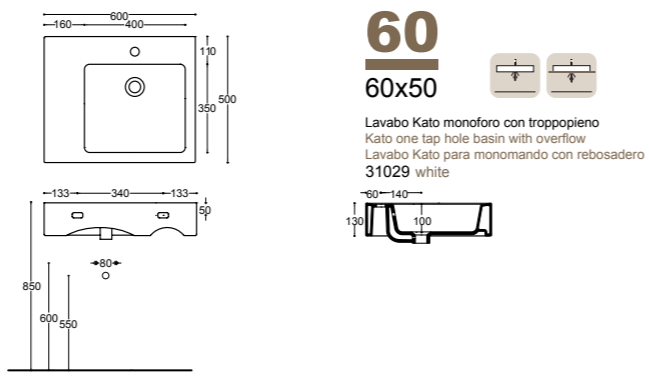

60
60x50
Lavabo Kato monoforo con troppopieno
Kato one tap hole basin with overflow
Lavabo Kato para monomando con rebosadero
31029 white

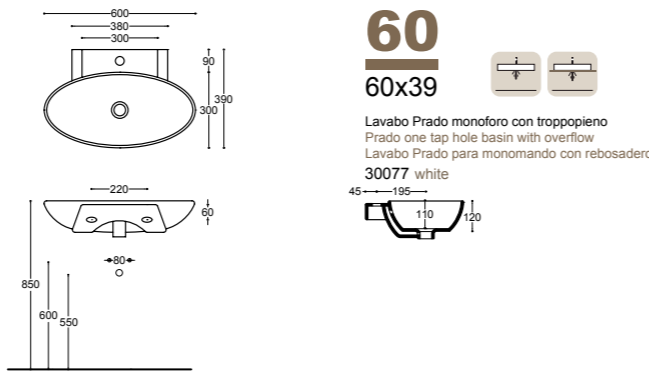

60
60x39
Lavabo Prado monoforo con troppopieno
Prado one tap hole basin with overflow
Lavabo Prado para monomando con rebosadero
30077 white

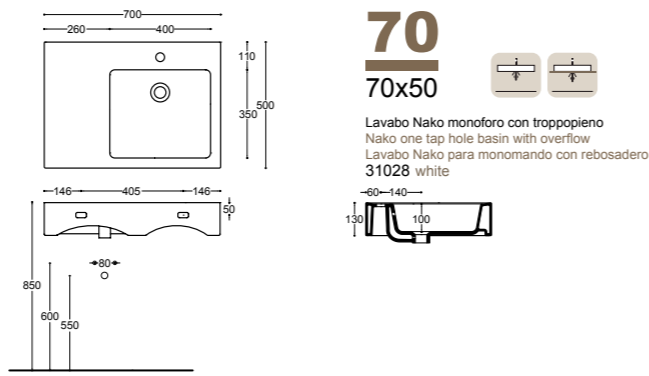

70
70x50
Lavabo Nako monoforo con troppopieno
Nako one tap hole basin with overflow
Lavabo Nako para monomando con rebosadero
31028 white

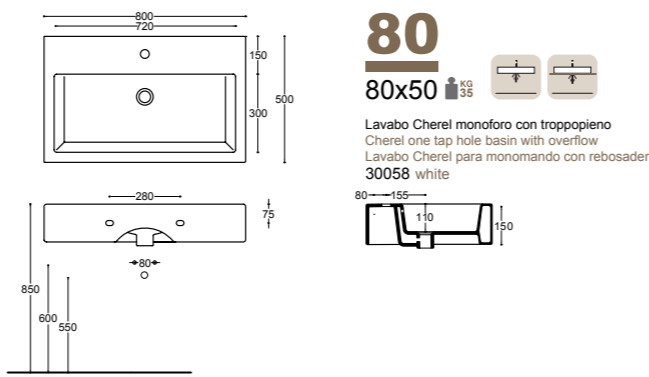

80
80x50
Lavabo Cherel monoforo con troppopieno
Cherel one tap hole basin with overflow
Lavabo Cherel para monomando con rebosadero
30058 white

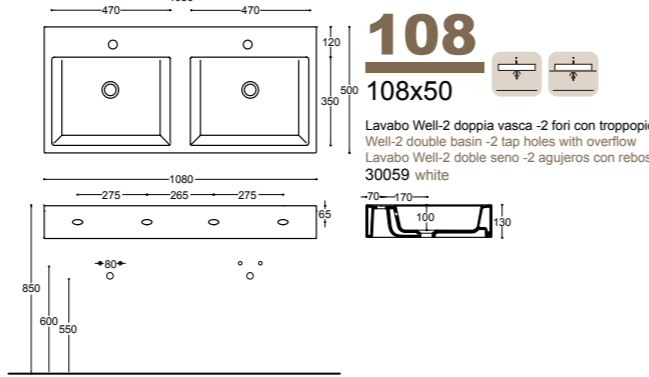

108
108x50
Lavabo Well-2 doppia vasca -2 fori con troppopieno
Well-2 double basin -2 tap holes with overflow
Lavabo Well-2 doble seno -2 agujeros con rebosadero
30059 white

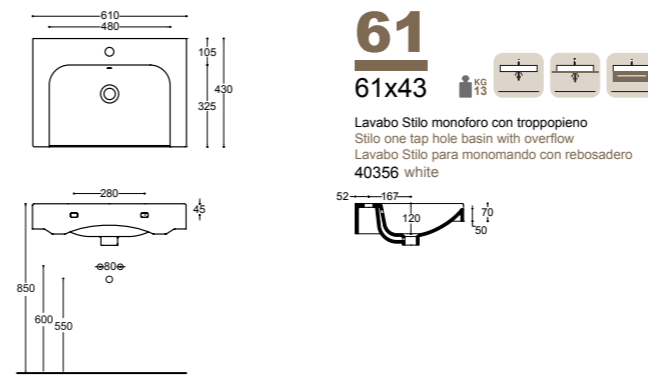

61
61x43
Lavabo Stilo monoforo con troppopieno
Stilo one tap hole basin with overflow
Lavabo Stilo para monomando con rebosadero
40356 white

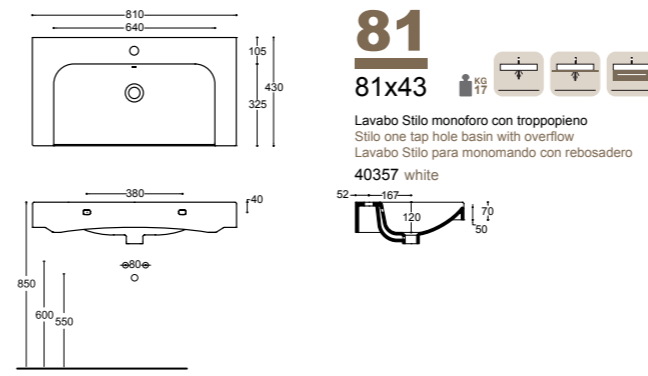

81
81x43
Lavabo Stilo monoforo con troppopieno
Stilo one tap hole basin with overflow
Lavabo Stilo para monomando con rebosadero
40357 white

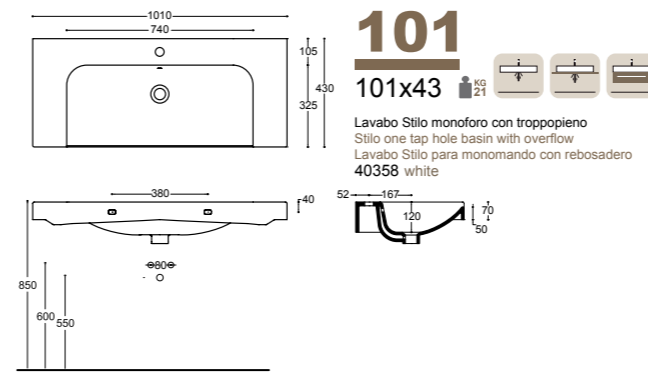

101
101x43
Lavabo Stilo monoforo con troppopieno
Stilo one tap hole basin with overflow
Lavabo Stilo para monomando con rebosadero
40358 white

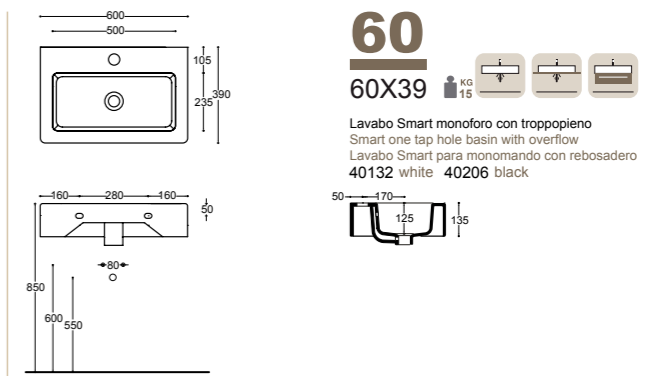

60
60x39
Lavabo Smart monoforo con troppopieno
Smart one tap hole basin with overflow
Lavabo Smart para monomando con rebosadero
40132 white 40206 black

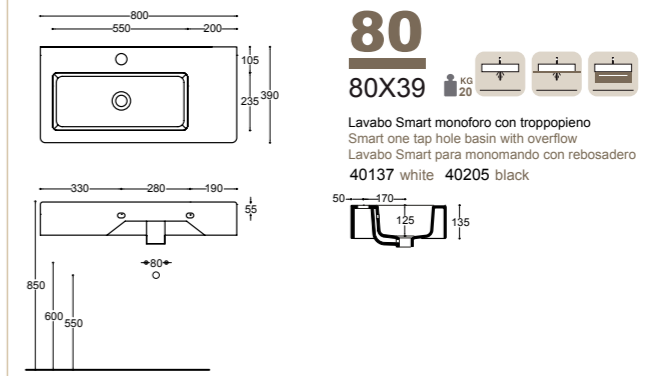

80
80x39
Lavabo Smart monoforo con troppopieno
Smart one tap hole basin with overflow
Lavabo Smart para monomando con rebosadero
40137 white 40205 black

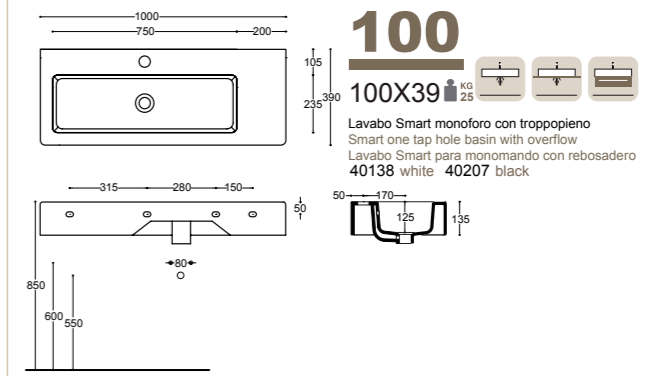

100
100x39
Lavabo Smart monoforo con troppopieno
Smart one tap hole basin with overflow
Lavabo Smart para monomando con rebosadero
40138 white 40207 black

Installazione:
Installation:
Instalación:

- Sospeso
Wall hung
Suspendido
- Appoggio
Sit on top
Apoyo
- Su colonna
With legs
Con pedestal
- Con piedini
With legs
Con patas
- Sottopiano
Under-counter
Bajo encimera
- Semincasso
Semi recessed
Semiencastré
- Su mobile
Cabinet basin
Con mueble

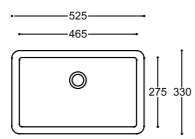

52

52x33 ^{KG}

Lavabo sottopiano Enjoy senza troppopieno
Enjoy under - counter washbasin without overflow
Lavabo bajo encimera Enjoy sin rebosadero
30072 white

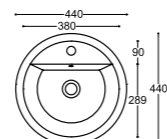
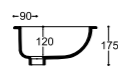

44

44x44 ^{KG}

Lavabo d'appoggio On monoforo con troppopieno
"On" one tap hole sit on top basin with overflow
Lavabo de apoyo On para monomando con rebosadero
31025 white

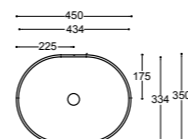
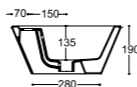

45

45x35 ^{KG}

Lavabo Cover d'appoggio senza troppopieno
Cover sit on top basin without overflow
Lavabo Cover de apoyo sin rebosadero
40582 white 40795 cherry
40796 black 40798 grey
40799 yellow 40800 platinum
40797 green

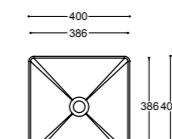

40

40x40 ^{KG}

Lavabo d'appoggio Neo senza troppopieno
Neo sit on top basin without overflow
Lavabo de apoyo Neo sin rebosadero
30117 white
30144 black
30142 yellow
30143 grey
30141 cherry

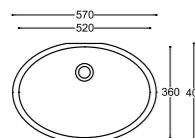
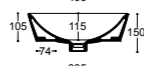

57

57x40 ^{KG}

Lavabo sottopiano Tibex senza troppopieno
Tibex under - counter washbasin without overflow
Lavabo bajo encimera Tibex sin rebosadero
30074 white

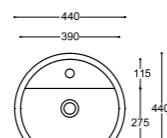
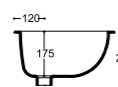

44

44x44 ^{KG}

Lavabo d'appoggio In monoforo con troppopieno
In one tap hole sit on top basin with overflow
Lavabo de apoyo In para monomando con rebosadero
31032 white

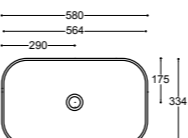
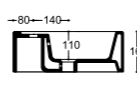

58

58x35 ^{KG}

Lavabo Cover d'appoggio senza troppopieno
Cover sit on top basin without overflow
Lavabo Cover de apoyo sin rebosadero
40234 white 40242 cherry
40240 black 40241 grey
40243 yellow 40239 platinum
40245 green

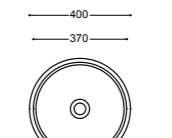

40

40x40 ^{KG}

Lavabo d'appoggio Kali senza troppopieno
Kali sit on top basin without overflow
Lavabo de apoyo Kali sin rebosadero
30118 white
30149 black
30147 yellow
30148 grey
30146 cherry

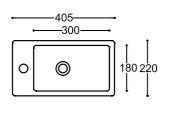
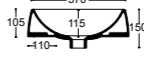

22

22x40 ^{KG}

Lavabo Small monoforo senza troppopieno
Small one tap hole basin without overflow
Lavabo Small para monomando sin rebosadero

40216 white
40231 black
40847 grey
40233 platinum

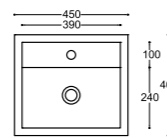
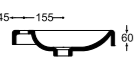

45

45x40 ^{KG}

Lavabo d'appoggio Uka monoforo con troppopieno
Uka one tap hole sit on top basin with overflow
Lavabo de apoyo Uka para monomando con rebosadero
31034 white

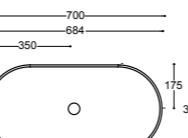
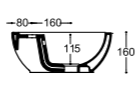

70

70x35 ^{KG}

Lavabo Cover d'appoggio senza troppopieno
Cover sit on top basin without overflow
Lavabo Cover de apoyo sin rebosadero
40583 white 40801 cherry
40802 black 40804 grey
40805 yellow 40806 platinum
40803 green

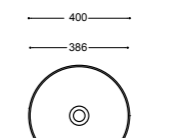

40

40x40 ^{KG}

Lavabo d'appoggio Tecno senza troppopieno
Tecno sit on top basin without overflow
Lavabo de apoyo Tecno sin rebosadero
30119 white
30154 black
30152 yellow
30153 grey
30151 cherry

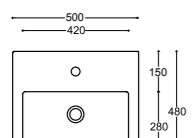
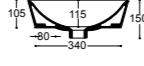

50

50x48 ^{KG}

Lavabo Nike monoforo con troppopieno
Nike one tap hole basin with overflow
Lavabo Nike para monomando con rebosadero
30056 white

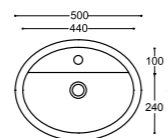
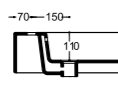

50

50x40 ^{KG}

Lavabo d'appoggio Out monoforo con troppopieno
Out one tap hole sit on top basin with overflow
Lavabo de apoyo Out para monomando con rebosadero
31033 white

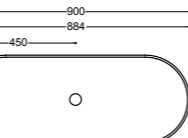
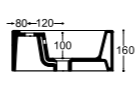

90

90x35 ^{KG}

Lavabo Cover d'appoggio senza troppopieno
Cover sit on top basin without overflow
Lavabo Cover de apoyo sin rebosadero
40584 white 40807 cherry
40808 black 40810 grey
40811 yellow 40812 platinum
40809 green

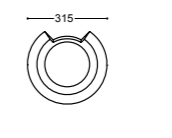

31

31x30 ^{KG}

Semicolonna Tecno
Tecno half pedestal
Semipedestal Tecno
30120 white
30159 black
30157 yellow
30158 grey
30156 cherry



* Altezza massima sifone
* Maximum height of the siphon
* Altura máxima del sifón

Articoli supplementari Additional items Artículos adicionales

Sifone ribassato Short siphon Sifón corto	40170
Sifone Siphon Sifón	31056
Fissaggi per lavabo Fixings for washbasin Anclajes para lavabo	30020

Installazione:
Installation:
Instalación:



Sospeso
Wall hung
Suspendido



Appoggio
Sit on top
Apoyo



Su colonna
With pedestal
Con pedestal



Con piedini
With legs
Con patas



Sottopiano
Under-counter
Bajo encimera



Semincasso
Semi recessed
Semiencastré



Su mobile
Cabinet basin
Con mueble

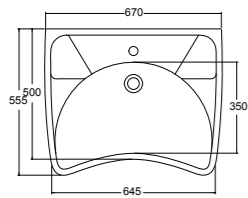

67
67x55



Lavabo ergonomico Comfort monoforo con troppopieno su richiesta
Ergonomic "Comfort" one tap hole basin with overflow on demand
Lavabo ergonómico Comfort para monomando con rebosadero opcional
40867 white

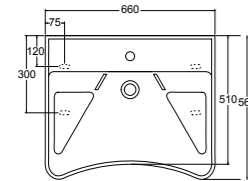
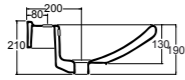
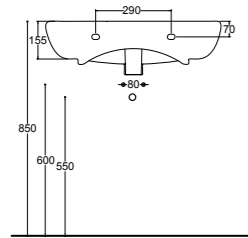

66
66x56



Lavabo ergonomico Comfort monoforo con troppopieno su richiesta
Ergonomic "Comfort" one tap hole basin with overflow on demand
Lavabo ergonómico Comfort para monomando con rebosadero opcional
40542 white

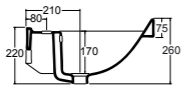
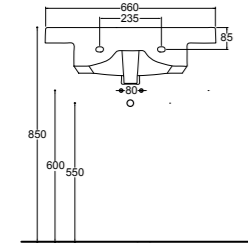

Staffa fissa di fissaggio lavabo
Fixed fixing bracket for washbasin
Fijación fija para lavabo
40544



Staffa con regolazione pneumatica
Fixing bracket with pneumatic regulation
Fijación con regulación neumática
40545



Maniglione
Grab rail
Asa de baño recta
L.30 D2 L.40 D2.1 L.50 D2.2
L.60 D2.3 L.90 D2.4



Barra di sostegno ribaltabile cm 80
Cm 80 fold up grab rail
Asa de sujeción abatible cm 80
D3



Barra di sostegno ribaltabile con porta rotolo
Cm 80 fold up grab rail with toilet tissue dispenser
Asa de sujeción abatible con porta rotolo cm 80
D3.1



Barra di sostegno con rinforzo dx o sx cm 80
Cm 80 left or right hand reinforced grab rail
Asa de sujeción con refuerzo dcha o izqda cm 80
D4



Seggiolino ribaltabile fisso per doccia
Fixed fold up shower seat
Asiento abatible fijo para ducha
D11.1



Sedile ribaltabile asportabile per doccia
Fold up portable shower seat
Asiento abatible y extraíble para ducha
D11



Copribordo in termoformato per wc disabili
Removable plastic toilet seat for disabled wc
Aro para inodoro termoformado de fácil accesibilidad
40543

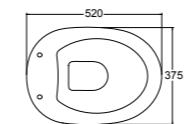

52
52x37

WC scarico a pavimento
WC floor trap
Inodoro salida V
40851 white

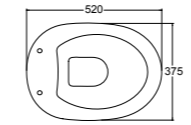
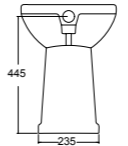
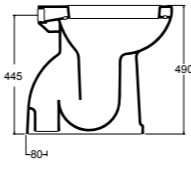

52
52x37

WC - Bidet scarico a pavimento
WC - Bidet floor trap
Inodoro - Bidé salida V
40853 white

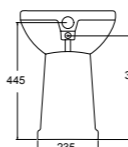
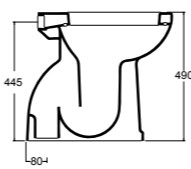

* Entrata acqua
* Inlet water
* Entrada agua

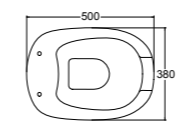

50
50x38

WC con apertura scarico a pavimento
WC floor trap with front aperture
Inodoro salida V con apertura
40534 white

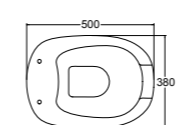
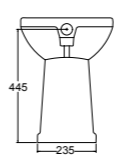
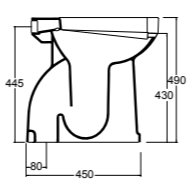

50
50x38

WC - Bidet con apertura scarico a pavimento
WC - Bidet floor trap with front aperture
Inodoro - Bidé con apertura salida V
40855 white

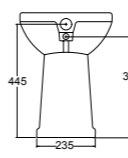
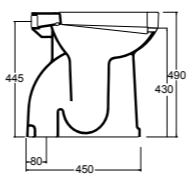

* Entrata acqua
* Inlet water
* Entrada agua

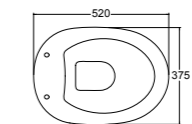

52
52x37

WC scarico a parete
WC wall trap
Inodoro salida H
40852 white

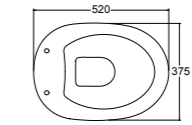
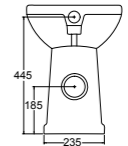
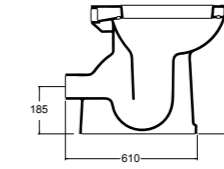

52
52x37

WC - Bidet scarico a parete
WC - Bidet wall trap
Inodoro - Bidé salida H
40854 white

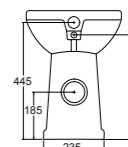
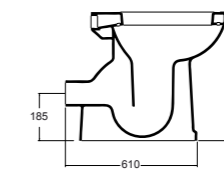

* Entrata acqua
* Inlet water
* Entrada agua

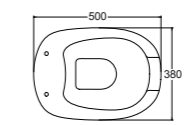

50
50x38

WC con apertura scarico a parete
WC wall trap with front aperture
Inodoro salida H con apertura
40535 white

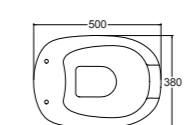
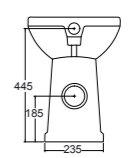
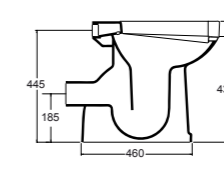

50
50x38

WC - Bidet con apertura scarico a parete
WC - Bidet wall trap with front aperture
Inodoro - Bidé con apertura salida H
40856 white

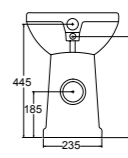
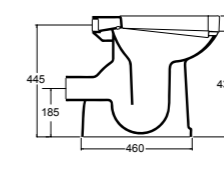

* Entrata acqua
* Inlet water
* Entrada agua

Installazione:
Installation:
Instalación:



Sospeso
Wall hung
Suspendido



Appoggio
Sit on top
Apoyo

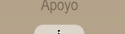

Su colonna
With pedestal
Con pedestal

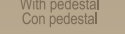

Con piedini
With legs
Con patas



Sottopiano
Under-counter
Bajo encimera



Semincasso
Semi recessed
Semiencastré

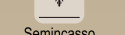

Su mobile
Cabinet basin
Con mueble



ISTITUTO PER LA TUTELA DEI PRODUTTORI ITALIANI

Made in Italy 100% Certificate

REGISTRAZIONE N° IT01.IT/698.023.M

SI ATTESTA CHE
This is to certify that

CERAMICA ALTHEA

E' UN MARCHIO CERTIFICATO AVENTE I REQUISITI DEL SISTEMA IT01 - 100% QUALITA' ORIGINALE ITALIANA
acts according to system IT01 - 100% Original Italian Quality

QUESTA CERTIFICAZIONE E' INOLTRE VALIDA PER IL SEGUENTE CAMPO APPLICATIVO:
This certificate is also valid for the following product or service range:

PRODOTTI IGIENICO SANITARI IN CERAMICA
Hygienic Sanitary Products

DITTA PRODUTTRICE E DISTRIBUZIONE
Manufacturer and distribution Company

CERAMICA ALTHEA SPA
Viale delle Industrie, 9 - 01033 Civita Castellana (VT)

SISTEMA IT01 - 100% QUALITA' ORIGINALE ITALIANA
The certified Company:

QUESTI PRODOTTI SONO:
These products are:

A - FABBRICATI INTERAMENTE IN ITALIA
Entirely Made in Italy

B - REALIZZATI CON SEMILAVORATI ITALIANI
Made with Italian components

C - COSTRUITI CON MATERIALI NATURALI
DI QUALITA' E DI PRIMA SCELTA
Made with natural top quality materials

D - REALIZZATI CON DISEGNI E PROGETTAZIONE
ESCLUSIVI DELL'AZIENDA

Made according to the Company's exclusive styles and designs

E - COSTRUITI ADOTTANDO LE LAVORAZIONI
ARTIGIANALI, TRADIZIONALI TIPICHE ITALIANE

Made according to the typical Italian craftsmanship and tradition

Organismo Asseverante
Supporting unit:
PROMINDUSTRIA SPA



Stamp / Trade Mark
Timbro dell'Istituto

MILANO, 28/02/2013

WALTER MARTINI
President

NAZZARENO VITA
Director

LA VALIDITA' DEL PRESENTE CERTIFICATO MADE IN ITALY E' SUBORDINATA AL RIESAME COMPLETO DEL SISTEMA CON PERIODICITA' ANNUALE
The validity of this Made in Italy Certificate is subjected to a periodical complete annual inspection

madeinitaly.org



CERTIFICATO DEL SISTEMA DI GESTIONE PER LA QUALITÀ QUALITY MANAGEMENT SYSTEM CERTIFICATE

Si dichiara che il sistema di gestione per la Qualità dell'Organizzazione:
We certify that the Quality Management System of the Organization:

**CERAMICA ALTHEA
S.p.A.**

Reg. No: 3619 - A

Indirizzo/Address:

Loc. Prataroni - Zona Industriale
01030 Civita Castellana VT Italia

È conforme alla norma/Is in compliance with the standard:

UNI EN ISO 9001:2008
ISO 9001:2008

Per i seguenti prodotti-servizi/For the following products-services:

Progettazione e produzione di articoli igienico-sanitari in ceramica
Design and manufacturing of ceramic sanitary wares

EA: 15

Il mantenimento della certificazione è soggetto a sorveglianza annuale e subordinato al rispetto dei requisiti essenziali CERMET.
Maintenance of the certification is subject to annual survey and dependent upon the observance of CERMET basic requirements.

Rilascio certificato/Certificate issuance: 2003-03-20

Ultima modifica/Last modification: 2012-05-23

Prossimo rinnovo/Following renewal: 2015-03-19

Direttore Commerciale e Operativo
Sales and Operations Manager
Gianpiero Belcredi

Direttore Generale
General Manager
Rodolfo Trippodo



ISO N° 9001
DIN N° 9000
PRC N° 9000

EN N° 9001
EN N° 9000



CERMET Soc. Cons. a r.l. - Headquarter Italy - Via Cadriano 23 - 40057 Cadriano di Granarolo (BO) - Tel +39.051.459.3.111 - Fax +39.051.763.382 - www.cermet.it

CERAMICA ALTHEA

CONDIZIONI GENERALI DI VENDITA

ORDINAZIONI:

dovranno essere passate alla società e dalla stessa confermate, sia per i prezzi sia per il termine di consegna. La merce è venduta franco fabbrica e viaggia, in ogni caso, a rischio e pericolo del committente.

TRASPORTO :

rimane sempre a carico del committente per conto del quale la società esegue la spedizione.

IMBALLO :

effettuato su pallets verrà addebitato il costo del 3% della fornitura.

PREZZI:

la società si riserva la facoltà di variare i prezzi senza alcun preavviso.In ogni caso i prezzi validi saranno quelli del listino in vigore al momento della consegna. Tutti i prezzi si intendono esclusi IVA.

PAGAMENTI:

i pagamenti debbono essere effettuati, esclusivamente, presso la sede della società fornitrice, salvo patto contrario espresso. Il mancato pagamento di una eventuale precedente fornitura autorizza la Società Ceramica Althea Spa a sospendere le forniture e ad annullare eventuali ordini in portafoglio.

In caso di contestazione di qualsiasi natura il committente non ha diritto di

sospendere i pagamenti.

CONSEGNA:

i termini di consegna sono puramente indicativi. In ordine a tali termini, pertanto, la Società fornitrice non potrà assumere, responsabilità di qualsiasi genere, salvo i casi di pattuizione espressa.

RECLAMI:

dovranno pervenire alla ns. Sede non oltre otto giorni dal ricevimento della merce. In ogni caso non si accettano merci di ritorno, senza che sia intercorso un accordo in tal senso con la fornitrice.

RISERVA DI PROPRIETA:

fino a che il pagamento non sia stato completato la merce rimane di proprietà della fornitrice.

DATI RIGUARDANTI IL COMMITTENTE:

il committente è responsabile di tutti i dati identificativi, in particolare, per quanto si riferisce alle norme relative all'anagrafe tributaria (Codice Fiscale).

DOMICILIO LEGALE:

per qualsiasi controversia, competente è il Foro di Viterbo (Italia).

INTERESSI MORATORI:

qualora si verificassero ritardi dei pagamenti verranno addebitati gli interessi al tasso praticato dagli istituti di Credito all'atto dell'addebito.

DIMENSIONI

Le misure di ciascun lavabo sono da considerarsi indicative e suscettibili di variazioni a causa delle caratteristiche peculiari della lavorazione ceramica.

Ceramica Althea Spa si riserva il diritto di apportare, in qualsiasi momento modifiche tecniche, costruttive e dimensionali utili al miglioramento della produzione.

Le tonalità degli smalti possono subire lievi variazioni da considerarsi in tolleranza a causa delle caratteristiche peculiari della lavorazione ceramica.

GENERAL SALE TERMS

ORDERS:

must be placed with the firm that will confirm both prices and delivery terms. Goods are sold on an ex-factory basis and transport is carried out at the customer's own risk.

TRANSPORT:

is always to be paid by the customer on whose behalf the firm may ship the goods.

PACKAGING :

on pallets, 3% of the consignment value will be debited.

PRICES:

the firm reserves the right to vary prices without any previous notice. In any case, the prices to be considered valid are those contained in the price-list in force at the time of delivery.

Prices do not include V.A.T.

PAYMENT:

must be made exclusively to the supplying firm unless otherwise agreed upon. Failure to pay a previous supply allows the firm Ceramica Althea Spa to stop shipping goods and cancel any pending order. In case of any claims, the customer must not suspend payment.

DELIVERY:

dates are merely approximate. Consequently the supplying firm bears no responsibility for delivery dates, unless otherwise agreed upon.

WEIGHT AND SIZES:

these are approximate and therefore the firm bears no responsibility for them.

CLAIMS:

must be submitted to our head office within 8 days upon receipt of the goods. Goods will not be accepted back unless otherwise agreed upon with the manufacturer.

RIGHTS OF OWNERSHIP:

until payment is fully settled, the goods remain the property of the supplying firm.

CUSTOMER DETAILS:

the customer is responsible for all identification details provided, particularly for those referring to the tax register office (tax code).

LEGAL RESIDENCE:

for any controversy the competent court is the Court of Viterbo (Italy).

INTEREST ON DELAYED PAYMENTS:

should there be delay in payments, interest will be charged at the rate fixed by credit institutions at the moment of debiting.

DIMENSIONS

The measures of each basin are to be considered as approximate and susceptible to variations because of the specific characteristics of the ceramic workmanship.

Ceramica Althea Spa reserves the right to make, at any moment, technical, constructive and dimensional changes useful to improve the production.

CONDICIONES GENERALES DE VENTA

PEDIDOS:

los pedidos deben ser enviados a la sociedad y confirmados por ésta, sea por los precios y la fecha de entrega. La mercancía es vendida franco almacén y siempre viaja por cuenta y riesgo del comprador.

TRANSPORTE:

siempre es a cargo del comprador por demanda del cual la sociedad efectua la expedición.

EMBALAJE:

se realiza en palets y se adeudará el 3% del coste total del suministro.

PRECIOS:

la sociedad se reserva el derecho de modificar los precios sin preaviso. En todos los casos los precios válidos serán los de la tarifa vigente en el momento de la entrega. Los precios no incluyen I.V.A.

PAGOS:

los pagos deben ser efectuados exclusivamente a la sociedad vendedora, a excepción de previo pacto. El pago pendiente de un suministro ya servido autoriza a Ceramica Althea Spa a suspender el suministro y anular los pedidos en cartera. En el caso de incidencias de cualquier naturaleza el comprador no tiene derecho a retrasar/suspender los pagos.

ENTREGA:

la fecha de entrega es sólo orientativa. Según lo indicado la sociedad suministradora no podrá asumir ninguna responsabilidad salvo en los casos de previo pacto.

PESOS Y MEDIDAS:

ambos son aproximados. No se asumen responsabilidades por ellos siendo que las indicaciones de esta lista de precios son de carácter orientativo.

RECLAMACIONES:

tendrán que llegar a nuestra oficina dentro de los ocho días de la recepción de la mercancía y no después. En ningún caso se aceptará devolución de mercancía sin la autorización expresa de la sociedad suministradora.

RESERVA DE PROPIEDAD:

hasta que el pago no sea efectivo la mercancía es propiedad de la sociedad vendedora.

DATOS REFERENTES AL COMPRADOR:

el comprador es responsable de la correcta utilización de sus datos de identificación fiscal, en particular en lo referente a las normas relativas al Registro de Contribuyentes.

DOMICILIO LEGAL:

por cualquier controversia es competente el Foro de Viterbo (Italia).

INTERESES DE MOROSIDAD:

en el caso de retraso en los pagos se adeudarán los intereses según la tasa indicada por las Entidades Bancarias al momento del adeudo.

MEDIDAS

Las medidas de cada lavabo son orientativas y susceptibles de variaciones por las característi-cas peculiares de la fabricación de la cerámica.

Ceramica Althea SpA se reserva el derecho de aportar, en cualquier momento, cambios técnicos, constructivos, y de medida para la optimización de la producción.

Las tonalidades de los esmaltes pueden sufrir leves variaciones sujetas a la normativa, dadas las características peculiares de la producción de la cerámica.

ALLGEMEINE VERKAUFSBEDINGUNGEN

BESTELLUNGEN:

diese müssen im Unternehmen eingegangen sein und von ihnen bestätigt worden sein, sowohl in Bezug auf die Preise, als auch auf die Lieferzeiten. Die Ware wird frei Fabrik verkauft und reist in jedem Fall auf Risiko und Gefahr des Auftraggebers.

TRANSPORT:

immer zu Lasten des Auftraggebers, für den das Unternehmen die Spedition ausführt.

VERPACKUNG:

ausgeführt auf Paletten werden Kosten in Höhe von 3% der Lieferung auferlegt.

PREISE:

das Unternehmen behält sich die Befugnis vor, die Preise ohne jede Vorankündigung abzuändern. In jedem Fall werden die Preise der Preisliste angerechnet, die im Moment der Warenübergabe gültig ist. Alle Preise verstehen sich ausschliesslich MWST.

BEZAHLUNG:

die Bezahlungen dürfen ausschliesslich im Sitz der Lieferfirma ausgeführt werden, soweit nicht anders vereinbart. Das Ausbleiben der Zahlung einer eventuell vorhergehenden Lieferung autorisiert das Unternehmen Ceramica Althea Spa dazu, die Lieferung aufzuheben und eventuell anstehende Bestellungen zu annullieren. Bei Streitigkeiten jeglicher Natur hat der Auftraggeber nicht das Recht, die Zahlungen aufzuheben.

LIEFERUNG:

die Lieferbedingungen sind rein indikativ. In Bezug auf diese Bedingungen kann deshalb die Lieferfirma keinerlei Verantwortung übernehmen, soweit nicht anders vereinbart worden ist.

GEWICHTE UND MASSE:

beide sind annähernd. Man übernimmt keinerlei Verantwortung über diese, da die Angaben in der beigelegten Preisliste nur indikativen Charakter haben.

BESCHWERDEN:

diese müssen in unserem Firmensitz binnen acht Tagen ab Erhalt der Ware eingehen. In keinem Fall werden Warenrücksendungen akzeptiert, ohne dass mit der Lieferfirma vorher eine Vereinbarung in diesem Sinne getroffen worden ist.

EIGENTUMSVORBEHALT:

bis zur vollständigen Bezahlung bleibt die Ware Eigentum der Lieferfirma.

DATEN ÜBER DEN AUFTRAGGEBER:

der Auftraggeber ist Verantwortlich für alle angegebenen Daten, insbesondere für diejenigen, die sich auf fiskalische Angaben beziehen (Steuernummer).

GESETZLICHER WOHNSITZ:

für jegliche Streitigkeiten ist das Amtsgericht in Viterbo (Italien) zuständig.

VERZUGSZINSEN:

falls bei der Bezahlung Verspätungen eintreten, werden Zinsen in Höhe von dem Zinssatz auferlegt, der von den Kreditinstituten zum Moment des Zahlungseinzugs angewandt wird.

Design:
Maya Cohen

Rubinetterie:
daniel.it
remer.ue
altrosupergrif.com

Arredi:
falzonearredi.com

Print:
Telligraf srl

General Catalogue

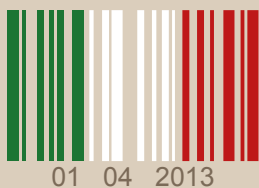

CERAMICA
ALTHEA

© Copyright Ceramica Althea SpA - Aprile 2013

Viale delle Industrie, 9
01033 Civita Castellana (VT) - Italy
tel - +39 0761542144 / fax - +39 0761542129
info@altheaceramica.it

www.altheaceramica.com